

Exchangeable head endmill

TUNGMEISTER

Tungaloy Report No. 381-G

Exchangeable Head Endmill Series

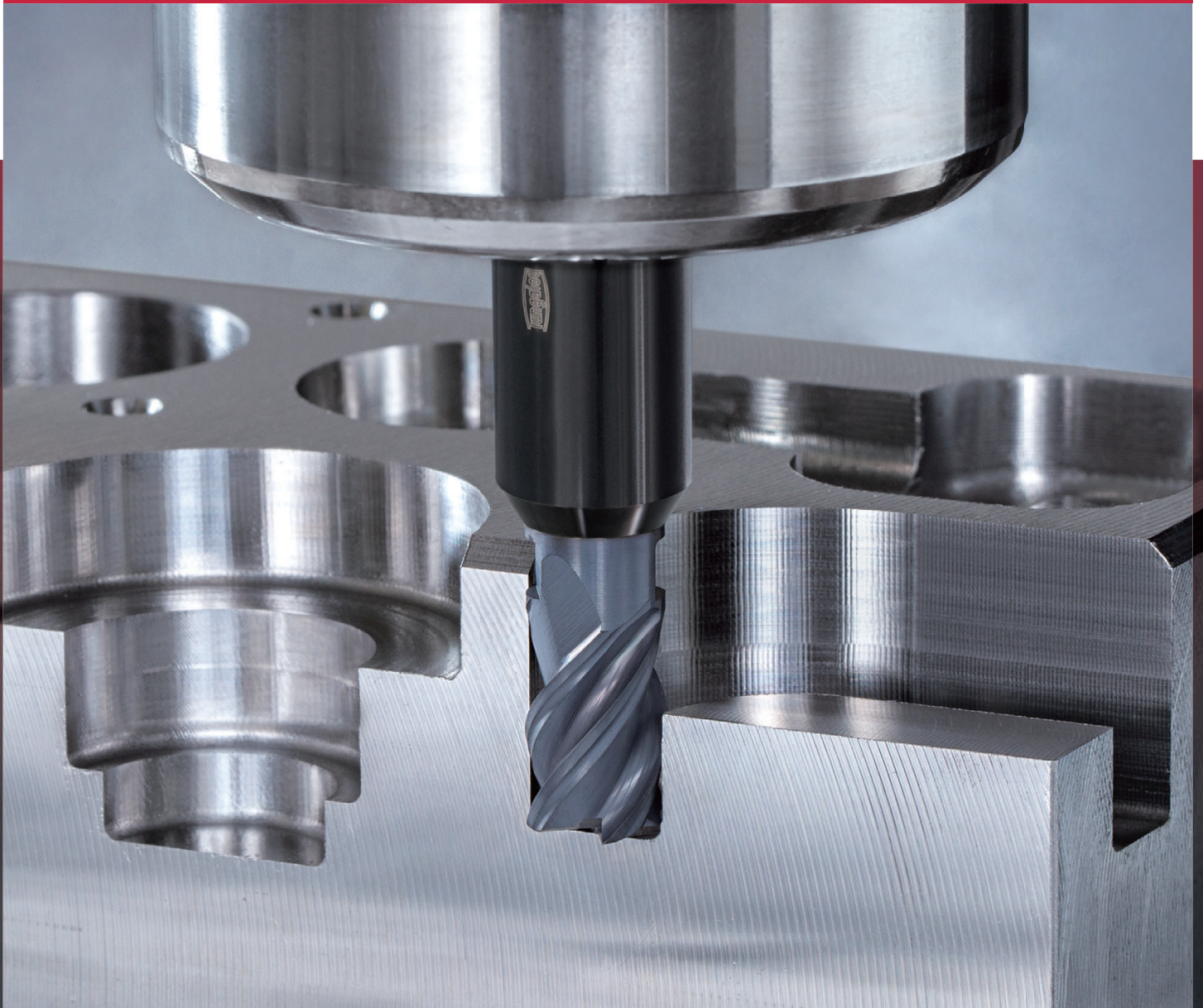

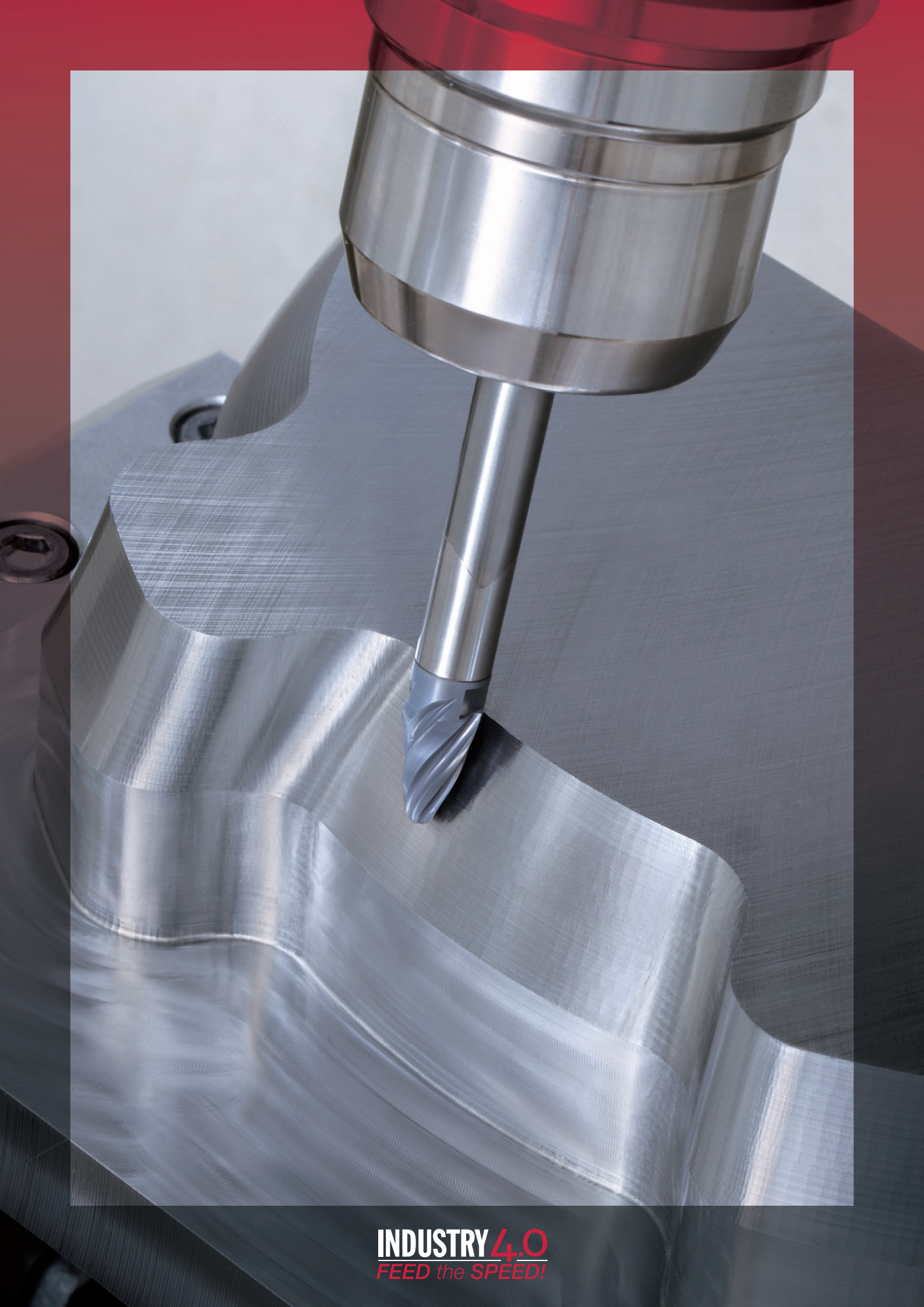

INDUSTRY 4.0
FEED the SPEED!

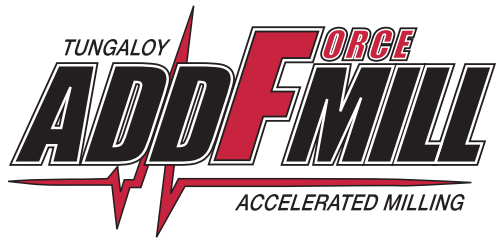

TUNGMEISTER



13,000 combinations for optimal performance

Optimal tool combination for maximum productivity

Significantly reduced tool indexing time improves machining efficiency



1 Wide range of geometries

45 kinds of geometries are available. The head indexing is easy and highly accurate with the precision thread.

2 Three kinds of shank material

Users can choose the most suitable combination according to the machining parameters, length and application required.

Steel: For general purpose

Carbide: For highly accurate machining due to excellent rigidity

Tungsten: Reduced chattering due to high vibration damping capacity



Straight shank & neck



Straight shank & taper neck



Straight shank & neck (carbide)



Straight (for slotting)



High rigidity shank



ER collet



Adaptor for TungFlex

No setup time

Machine downtime is decreased considerably. Simplified setup since only the head is indexed.

Increases productivity by 90%

Exchange time / Piece

TUNGMEISTER

less than 1 minute

Solid endmill 10 minutes

High accuracy and repeatability

Repeatability and accuracy are maintained due to full contact of both taper and face.

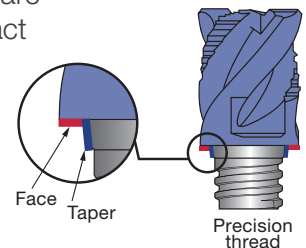
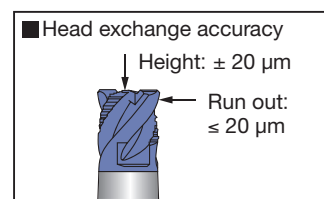

Constant and predictable tool life

Latest wear and fracture resistant grades

AH715 / AH735

Unique nano-multilayered coating using Tungaloy's latest technology providing 3 principal features.

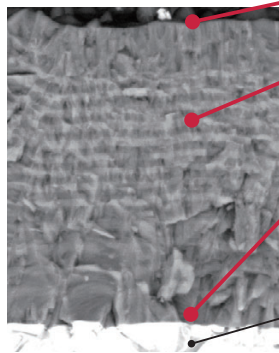

1. Resistance to built-up edge

Coating layer to resist built-up edge

2. Resistance to wear, oxidation, and fracture

Two coating layers for wear and oxidation resistance. Layered alternatively to prevent crack from propagating to fracture

3. Strong coating-substrate adhesion

Coating is provided with strong adhesion between the coating layer and carbide substrate to prevent coating delamination

Carbide substrate

AH715: Provides a good balance of wear and fracture resistance

AH735: Chipping and fracture resistance

Tool life comparisons

AH715 and **AH735** provide better tool life performance in a wide group of materials.

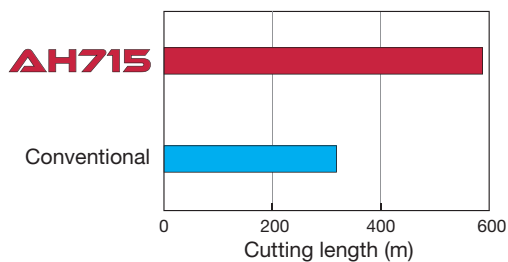

Shank : VSSD16L100S10-S
 Head : VED160L12.0R05-04S10
 Workpiece material : S55C / C55 (1055)
 Cutting speed : $V_c = 150$ m/min
 Feed per tooth : $f_z = 0.12$ mm/t
 Depth of cut : $a_p = 5$ mm
 Width of cut : $a_e = 1.5$ mm
 Machine : Vertical M/C, BT40

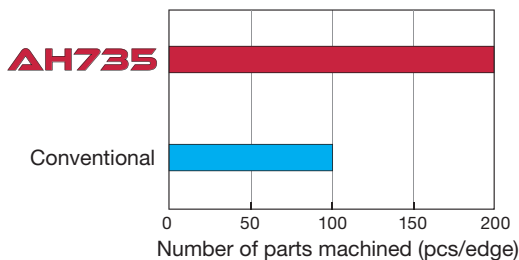

Shank : VSC120L100S08-C-A
 Head : VST217W2.50R020-4S08
 Workpiece material : Titanium alloy
 Cutting speed : $V_c = 50$ m/min
 Feed per tooth : $f_z = 0.1$ mm/t
 Depth of cut : $a_p = 4$ mm
 Width of cut : $a_e = 2.5$ mm
 Machine : Vertical M/C, HSK A63

Application range

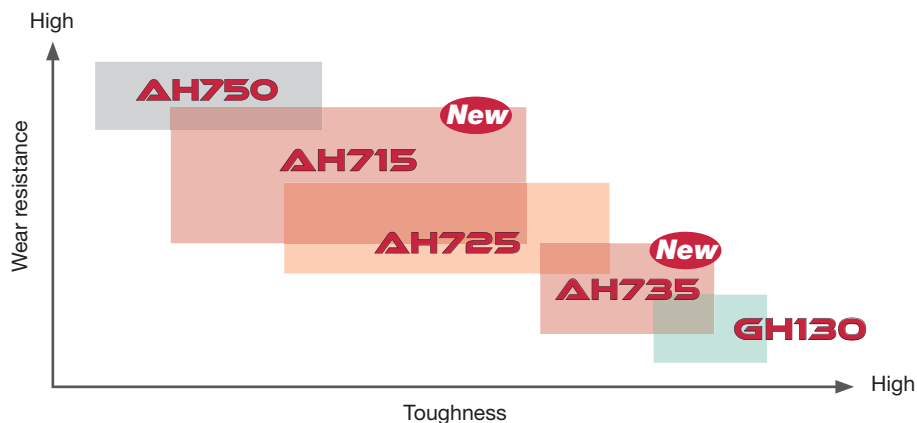

Enhanced tool lineup expands the series' machining capabilities, also offering AH715 and AH735 grades



New high-feed milling head with coolant through

Optimized front internal coolant allows effective cooling of the cutting edge, while facilitating smooth chip evacuation from the cutting area.

P.22 VFX**-04/06...



Extensive tool diameter range from 5 to 32 mm

Covers a broad range of applications from precision machining to large size parts.

P.12 -

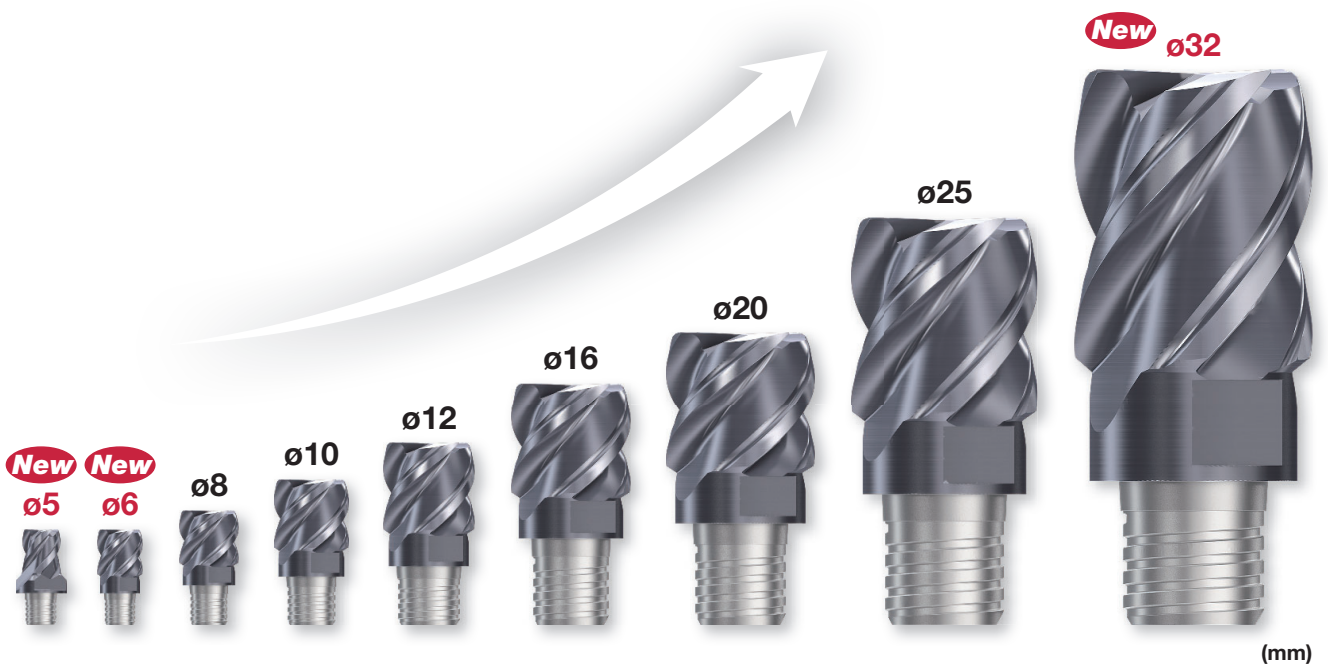



Square

VEH, VED



VEH...

VED**-07/09...

Roughing
VED**R...

Additional lineup for 1.5D long flute milling head series

New close-pitch milling head and serrated edge roughing head for expanded coverage.

P.12 -



Barrel

VBO



Lens

VBL



Bull nose

VBN

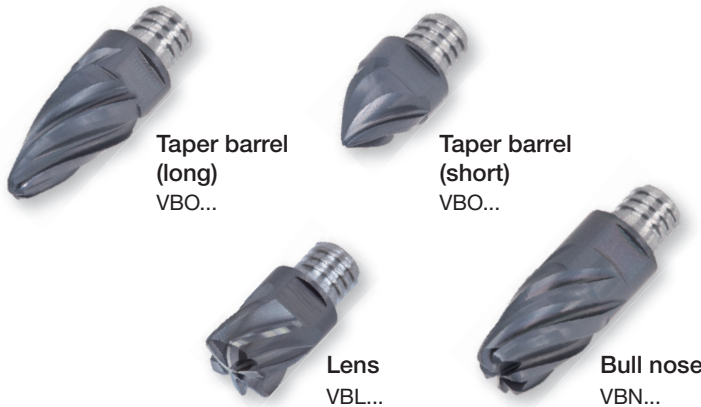

Taper barrel
(long)
VBO...

Taper barrel
(short)
VBO...

Lens
VBL...

Bull nose
VBN...

Additional lineup for 5-axis machine applications

Large radius cutting edge allows efficient finish machining of various contoured surfaces.

P.29 -



Face mill

VFM

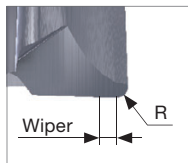

New face milling head

The **VFM** cutting edge incorporates a built-in wiper that will provide better surface quality than standard solid carbide endmills.

P.21 VFM...



Center hole

VDP



Type A

Type B

Enhanced lineup of center drill heads for small diameter bar stocks

A center hole as small as 1.0 mm in diameter can now be created with **TungMeister**. Now offering Type B drill.

P.36 VDP**-02...

TUNGMEISTER Quick Guide

















Square, Face mill, High feed

★ : First choice ☆ : Second choice

Head geometry	Designation	Appearance	Application			Tool dia. (mm)	No. of cutting edges	Cutting edge length		Feature	Corner geometry	Helix angle	CRKS	Workpiece material						Page
			Roughing	Semifinishing	Finishing			L/D	APMX (mm)					P	M	K	N	S	H	
Square	VEH...		✓	✓	✓	ø8 - ø20	4	0.6 - 0.8XD	5 - 15	First choice for square head, General Variable helix, Variable pitch	Corner radius	Variable	S05 - S12	★	★	★	☆	★	☆	12
	VEH...		✓	✓	✓	ø8 - ø32	4	1.2 - 1.5XD	12 - 38	First choice for square head, General Variable helix, Variable pitch Long edge type (Max ap = 1.2 ~ 1.5XD)	Corner radius	Variable	S05 - S21	★	★	★	☆	★	☆	12
	VEE**-04... VED**-04...		✓	✓	✓	ø5 - ø20	4	0.8XD	4 - 15	General	Corner radius	30/45	S04 - S12	★	★	★	☆	★	☆	13
	VEE**I...		✓	✓	✓	ø8 - ø25	4	0.6 - 0.8XD	5 - 22	General Variable pitch	Corner radius/ Chamfered	38	S05 - S15	★	★	★	☆	★	☆	14
	VEE**-03...		✓	✓	✓	ø7.7 - ø19.7	3	0.5XD	4 - 12	General For key way	Corner radius00	38/45	S05 - S12	★	★	★	☆	★	☆	14
	VEE**A02...		✓	✓	✓	ø10 - ø12	2	0.7XD	7 - 9	General For non-ferrous metal	Corner radius	45	S06 - S08				☆	★		15
	VEE**A03...		✓	✓	✓	ø8 - ø20	3	0.6XD	5 - 12	General For non-ferrous metal	Corner radius	45	S05 - S12				☆	★		15
	VEE**R...		✓			ø8 - ø25	4, 5, 6	0.6 - 0.8XD	5 - 22	Anti-chattering/ Serrated cutting edge	Chamfered	45	S05 - S15	★	★	★	☆	★	☆	16
	VED**R...		✓			ø8 - ø25	4, 5, 6	1.5XD	12 - 37	Anti-chattering/ Serrated cutting edge Long edge type (Max ap = 1.2 ~ 1.5XD)	Chamfered	47	S05 - S15	★	★	★	☆	★	☆	16
	VEE**C...		✓	✓		ø8 - ø25	4	0.6 - 0.8XD	5 - 22	Anti-chattering Roughing and Finishing edge combination	Chamfered	45	S05 - S15	★	★	★	☆	★	☆	17
	VED**-06..., VEE**-06...		✓	✓	✓	ø8 - ø12	6	0.6 - 0.8XD	5 - 9	Small width of cut (ae = 0.02XD)	Corner radius/ Chamfered	30/45/ 50	S05 - S08	☆	☆	☆		★	★	17
	VED**-08/10..., VEE**-08/10...		✓	✓	✓	ø16 - ø25	8, 10	0.8XD	12 - 22	Small width of cut (ae = 0.02XD)	Corner radius/ Chamfered	30/50	S10 - S15	☆	☆	☆		★	★	18
	VED**-07/09...		✓	✓	✓	ø8 - ø25	7, 9	1.5XD	12 - 37	Variable helix, Variable pitch Small width of cut (ae = 0.02XD) Long edge type (Max ap = 1.5XD)	Corner radius	Variable	S05 - S15	☆	☆	☆		★	★	18
Face mill	VFM...		✓	✓	✓	ø12 - ø25	6	0.3XD	3.6 - 7.5	Face milling	Corner radius	-	S05 - S10	★	★	★	☆	★	☆	21
High feed	VFX**-02...		✓			ø10 - ø20	2	0.06XD	0.6 - 1.5	High feed	-	-	S06 - S12	★	★	★	☆	★	★	22
	VFX**-04/06...		✓			ø12, ø16	4, 6	0.05XD	0.6 - 1.05	High feed With coolant hole	-	-	S08 - S10	★	★	★	☆	★	★	22







Profiling (ball, radius, barrel)

★ : First choice ☆ : Second choice

Head geometry	Designation	Appearance	Application			Tool dia. (mm)	No. of cutting edges	Feature	Helix angle	CRKS	Workpiece material						Page	
			Roughing	Semifinishing	Finishing						P	M	K	N	S	H		
 Ball	VBB**-BM...		✓	✓		ø8 - ø16	2	Economical type	0	S05 - S10	★	★	★	☆	★	★	24	
	VBB**-BG...				✓	ø8 - ø16	2	High accuracy h7 For hardened material	0	S05 - S10	★	★	★	☆	★	★	24	
	VBD**-BG...			✓	✓		ø8 - ø16	2	Low cutting force Helix cutting edge	30	S05 - S10	★	★	★	☆	★	★	24
	VBD**-BG-04... VBE**-BG-04...		✓	✓	✓	ø5 - ø25	4	Low cutting force Helix cutting edge	30/38	S04 - S15	★	★	★	☆	★	★	25	
	VBB**-SG...		✓	✓	✓	ø10 - ø20	2	High accuracy h7 Sphere cutting edge	0	S05 - S10	★	★	★	☆	★	★	25	
	VBE**-BGA...		✓	✓	✓	ø8 - ø20	2	For non-ferrous metal	45	S05 - S12				☆	★		25	
 Radius	VRB**-02... VRC**-02...		✓	✓		ø10 - ø20	2	Economical type	0/15	S06 - S12	★	★	★	☆	★	☆	27	
	VRD**-06...		✓	✓		ø8 - ø16	6	High productivity High No.of cutting edge	30	S05 - S10	★	★	★	☆	★	☆	27	
 Barrel	VBO...		✓	✓		ø8 - ø16	4, 5	High productive profiling Long edge type	30	S05 - S10	★	★	★	☆	★	☆	29	
	VBO...		✓	✓		ø10 - ø16	4	High productive profiling Short edge type	30	S06 - S10	★	★	★	☆	★	☆	29	
 Bull nose	VBN...		✓	✓		ø10 - ø16	6	High productive profiling	35	S06 - S10	★	★	★	☆	★	☆	29	
 Lens	VBL...		✓	✓		ø8 - ø16	6	High productive profiling	30	S05 - S10	★	★	★	☆	★	☆	30	





TUNGMEISTER Quick Guide

Multi-function (chamfering, spot drill, center hole, counterboring) ★ : First choice ☆ : Second choice

Head geometry	Designation	Appearance	Center edge (Z-feed capability)	Tool dia. (mm)	No. of cutting edges	Feature	Helix angle	CRKS	Workpiece material						Page
									P	M	K	N	S	H	
Chamfering	VCA**-04/06...		Without	ø10 - ø20	4, 6	Chamfering angle: 45°	0	S06 - S12	★	★	★	☆	★	☆	32
	VCW**-02...		Without	ø11.8	2	Chamfering angle:45° Back chamfering capability	0	S06	★	★	★	☆	★	☆	32
	VCR**-02...		Without	ø8 - ø20	2	Radius chamfering	0	S05 - S12	★	★	★	☆	★	☆	32
Chamfering Spot drill	VCP**-02...		With	ø8 - ø16.5	2	Chamfering angle: 30°, 45°, 60°	0	S05 - S10	★	★	★	☆	★	☆	34
	VDS...		With	ø8 - ø16	2	Chamfering angle: 45° Low cutting force Helix cutting edge	10	S05 - S10	★	★	★	☆	★	☆	34
Center hole	VDP**-02...		With	ø1.07 - ø6.46	2	For center hole	0	S04 - S12	★	★	★	☆	★	☆	36
Counterboring	VGC**-02...		With	ø7.8 - ø16	2	For counterboring	10	S05 - S10	★	★	★	☆	★	☆	37



Slotting

★ : First choice ☆ : Second choice

Head geometry	Designation	Appearance	Groove width (mm)	Tool dia. (mm)	No. of cutting edges	Feature	Edge shape	Helix angle	CRKS	Workpiece material						Page
										P	M	K	N	S	H	
Slotting	VST**-3...		1.2 - 3.17	ø15.7 - ø17.7	3	Slotting	Corner radius	0	S06	★	★	★	☆	★	☆	38
	VST**-4/6...		0.76 - 10	ø21.7 - ø27.7	4, 6	Slotting	Corner radius	0	S08, S10	★	★	★	☆	☆	☆	39
	VST**A45...		3.4 - 5.5	ø17.7 - ø21.7	3, 4	Slotting with 45° chamfer	Chamfered	0	S06, S08	★	★	★	☆	★	☆	39
	VTB**-06...		2 - 8	ø13.5 - ø25	6	T-slotting	Corner radius	0	S05 - S10	★	★	★	☆	★	☆	40
	VTB**C15-06...		2	ø13.5	6	T-slotting with 45° chamfer	Chamfered	0	S05	★	★	★	☆	★	☆	40







Indexable modular head

★ : First choice ☆ : Second choice







Head geometry	Designation	Appearance	Application			Tool dia. (mm)	No. of cutting edges	Cutting edge length		Feature	Corner geometry	CRKS	Workpiece material						Page	
			Roughing	Semifinishing	Finishing			APMX (mm)						P	M	K	N	S		H
 Indexable modular head	HPAV06-S		✓	✓		ø10 - ø16	2, 3, 4	6		Economical indexable insert type	Corner radius	S05 - S10	★	★	★	★	★	★	★	42

Threading

★ : First choice ☆ : Second choice

Head geometry	Designation	Appearance	Feature	Wiper edge	No. of cutting edges	Tool dia. (mm)	Internal/ External	Thread type	Min. thread size	CRKS	Workpiece material						Page		
											P	M	K	N	S	H			
 Threading	VMT***IS		Full profile	With	3 - 6	ø10 - ø16	Internal	ISO metric	M12X0.75	S05 - S08	★	★	★	☆	★	☆	★	☆	44
	VMT***UN		Full profile	With	3, 4, 5	ø10 - ø16	Internal	Unified	9/16-24 UNEF	S05 - S08	★	★	★	☆	★	☆	★	☆	44
	VMT***W		Full profile	With	4	ø10, 16	Internal	Whitworth	G1/4	S05, S08	★	★	★	☆	★	☆	★	☆	45
	VTR***IS		Partial profile	Without	3, 4	ø15.7 - ø21.7	Internal/ External	60° partial profile	M20X0.5	S06, S08	★	★	★	☆	★	☆	★	☆	45
	VTR***W		Partial profile	Without	4	ø21.7	Internal/ External	55° partial profile	G3/4	S08	★	★	★	☆	★	☆	★	☆	45

Shank

Shank	Neck	Appearance	Material				Page
			Steel	Carbide	Carbide (with coolant hole)	Tungsten (with coolant hole)	
Straight	Straight		✓	✓	✓	✓	48, 49
Weldon	Straight		✓	-	-	-	50
Straight	Taper		✓	✓	-	✓	50, 51
High rigidity shank			✓	✓	-	-	48
Straight (slotting)			✓	✓	✓	-	51
Adaptor for TungFlex			✓	-	-	-	52
ER collet			✓	-	-	-	52

HEADS

VEH...

4 flute, roughing - finishing, variable helix and pitch

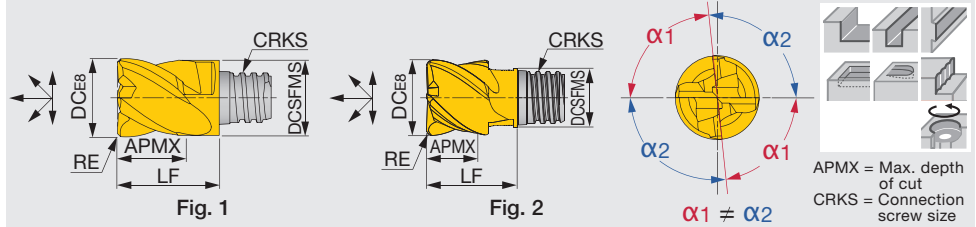

Designation	AH715	AH725	NOF	FHA	DC	DCSFMS	APMX	RE	CRKS	LF	Wrench	Torque*	Fig.
VEH080L05.0R05I04S05	●	●	4	41° - 45°	8	7.7	5	0.5	S05	10	KEYV-S05	7	1
VEH080L05.0R10I04S05	●	●	4	41° - 45°	8	7.7	5	1	S05	10	KEYV-S05	7	1
VEH100L07.0R10I04S05	●	●	4	41° - 45°	10	7.7	7	1	S05	12.8	KEYV-S05	7	2
VEH100L07.0R05I04S06	●	●	4	41° - 45°	10	9.7	7	0.5	S06	13	KEYV-S06	10	1
VEH100L07.0R10I04S06	●	●	4	41° - 45°	10	9.7	7	1	S06	13	KEYV-S06	10	1
VEH120L09.0R10I04S06	●	●	4	41° - 45°	12	9.3	9	1	S06	14.3	KEYV-S06	10	2
VEH120L09.0R05I04S08	●	●	4	41° - 45°	12	11.7	9	0.5	S08	16.5	KEYV-S08	15	1
VEH120L09.0R10I04S08	●	●	4	41° - 45°	12	11.7	9	1	S08	16.5	KEYV-S08	15	1
VEH160L12.0R10I04S08	●	●	4	41° - 45°	16	11.7	12	1	S08	20	KEYV-S08	15	2
VEH160L12.0R05I04S10	●	●	4	41° - 45°	16	15.3	12	0.5	S10	20.5	KEYV-S10	28	1
VEH160L12.0R10I04S10	●	●	4	41° - 45°	16	15.3	12	1	S10	20.5	KEYV-S10	28	1
VEH200L15.0R05I04S12	●	●	4	41° - 45°	20	18.3	15	0.5	S12	25.5	KEYV-S12	28	1
VEH200L15.0R10I04S12	●	●	4	41° - 45°	20	18.3	15	1	S12	25.5	KEYV-S12	28	1

* Recommended clamping torque (N-m)
2 pieces per package

● : New product
● : Line up

VEH...

4 flute, roughing - finishing, variable helix and pitch

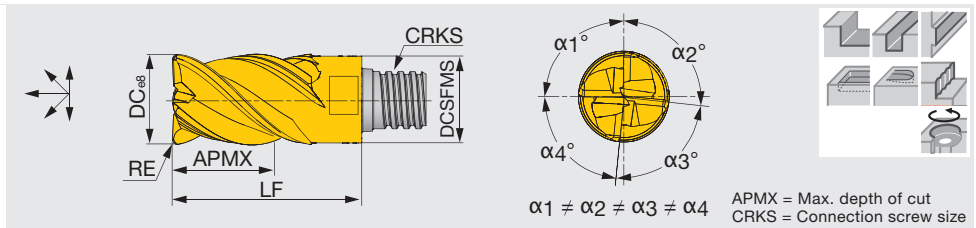

Designation	AH715	NOF	FHA	DC	DCSFMS	APMX	RE	CRKS	LF	Wrench	Torque*
VEH080L12.0R05I04S05	●	4	41° - 45°	8	7.7	12	0.5	S05	18	KEYV-S05	7
VEH080L12.0R10I04S05	●	4	41° - 45°	8	7.7	12	1	S05	18	KEYV-S05	7
VEH100L15.0R05I04S06	●	4	41° - 45°	10	9.7	15	0.5	S06	22	KEYV-S06	10
VEH100L15.0R10I04S06	●	4	41° - 45°	10	9.7	15	1	S06	22	KEYV-S06	10
VEH120L18.0R05I04S08	●	4	41° - 45°	12	11.7	18	0.5	S08	27	KEYV-S08	15
VEH120L18.0R10I04S08	●	4	41° - 45°	12	11.7	18	1	S08	27	KEYV-S08	15
VEH160L24.0R05I04S10	●	4	41° - 45°	16	15.3	24	0.5	S10	33.5	KEYV-S10	28
VEH160L24.0R10I04S10	●	4	41° - 45°	16	15.3	24	1	S10	33.5	KEYV-S10	28
VEH200L30.0R05I04S12	●	4	41° - 45°	20	18.45	30	0.5	S12	41	KEYV-S12	28
VEH200L30.0R10I04S12	●	4	41° - 45°	20	18.45	30	1	S12	41	KEYV-S12	28
VEH250L37.0R05I04S15	●	4	41° - 45°	25	23.9	37	0.5	S15	52.5	KEYV-W20	40
VEH250L37.0R10I04S15	●	4	41° - 45°	25	23.9	37	1	S15	52.5	KEYV-W20	40
VEH320L38.0R00I04S21	●	4	41° - 45°	32	30	38	-	S21	55	KS-24	110
VEH320L38.0R10I04S21	●	4	41° - 45°	32	30	38	1	S21	55	KS-24	110

* Recommended clamping torque (N-m)
VEH080 - VEH160: 2 pieces per package
VEH200 - VEH320: 1 piece per package

● : New product
● : Line up

VEE**-04..., VED**-04...

4 flute, roughing - finishing, general

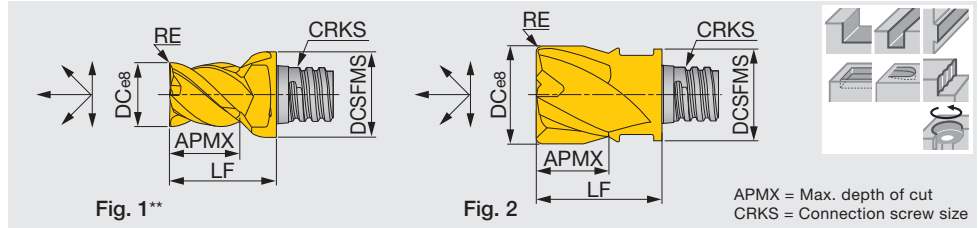

Designation	AH715	AH725	NOF	FHA	DC	DCSFMS	APMX	RE	CRKS	LF	Wrench	Torque*	Fig.
VEE050L04.0R05-04S04		●	4	45°	5	6	4	0.5	S04	8.5	KEYV-S05	4	1
VEE060L04.0R05-04S04		●	4	45°	6	5.8	4	0.5	S04	8.5	KEYV-S05	4	2
VEE060L05.0R00-04S05	●	●	4	45°	6	8	5	-	S05	10	KEYV-S05	7	1
VEE080L05.0R00-04S05		●	4	45°	8	7.7	5	-	S05	10	KEYV-S05	7	2
VED080L05.0R05-04S05		●	4	30°	8	7.7	5	0.5	S05	10	KEYV-S05	7	2
VED080L05.0R10-04S05		●	4	30°	8	7.7	5	1	S05	10	KEYV-S05	7	2
VED080L05.0R15-04S05		●	4	30°	8	7.7	5	1.5	S05	10	KEYV-S05	7	2
VEE100L07.0R00-04S06		●	4	45°	10	9.7	7	-	S06	13	KEYV-S06	10	2
VED100L07.0R05-04S06		●	4	30°	10	9.7	7	0.5	S06	13	KEYV-S06	10	2
VEE100L07.0R05-04S06		●	4	45°	10	9.7	7	0.5	S06	13	KEYV-S06	10	2
VED100L07.0R10-04S06		●	4	30°	10	9.7	7	1	S06	13	KEYV-S06	10	2
VEE100L07.0R10-04S06		●	4	45°	10	9.7	7	1	S06	13	KEYV-S06	10	2
VEE120L09.0R00-04S08	●	●	4	45°	12	11.7	9	-	S08	16.5	KEYV-S08	15	2
VED120L09.0R05-04S08		●	4	30°	12	11.7	9	0.5	S08	16.5	KEYV-S08	15	2
VEE120L09.0R05-04S08		●	4	45°	12	11.7	9	0.5	S08	16.5	KEYV-S08	15	2
VED120L09.0R10-04S08	●	●	4	30°	12	11.7	9	1	S08	16.5	KEYV-S08	15	2
VEE120L09.0R10-04S08		●	4	45°	12	11.7	9	1	S08	16.5	KEYV-S08	15	2
VEE160L12.0R00-04S10	●	●	4	45°	16	15.3	12	-	S10	20.5	KEYV-S10	28	2
VED160L12.0R05-04S10	●	●	4	30°	16	15.3	12	0.5	S10	20.5	KEYV-S10	28	2
VEE160L12.0R05-04S10		●	4	45°	16	15.3	12	0.5	S10	20.5	KEYV-S10	28	2
VED160L12.0R10-04S10		●	4	30°	16	15.3	12	1	S10	20.5	KEYV-S10	28	2
VEE160L12.0R10-04S10		●	4	45°	16	15.3	12	1	S10	20.5	KEYV-S10	28	2
VED160L12.0R15-04S10		●	4	30°	16	15.3	12	1.5	S10	20.5	KEYV-S10	28	2
VEE160L12.0R15-04S10		●	4	45°	16	15.3	12	1.5	S10	20.5	KEYV-S10	28	2
VED160L12.0R20-04S10		●	4	30°	16	15.3	12	2	S10	20.5	KEYV-S10	28	2
VEE160L12.0R20-04S10		●	4	45°	16	15.3	12	2	S10	20.5	KEYV-S10	28	2
VED160L12.0R30-04S10		●	4	30°	16	15.3	12	3	S10	20.5	KEYV-S10	28	2
VEE160L12.0R30-04S10	●	●	4	45°	16	15.3	12	3	S10	20.5	KEYV-S10	28	2
VED160L12.0R40-04S10		●	4	30°	16	15.3	12	4	S10	20.5	KEYV-S10	28	2
VEE160L12.0R40-04S10		●	4	45°	16	15.3	12	4	S10	20.5	KEYV-S10	28	2
VEE200L15.0R00-04S12		●	4	45°	20	18.3	15	-	S12	25.5	KEYV-S12	28	2
VED200L15.0R05-04S12		●	4	30°	20	18.3	15	0.5	S12	25.5	KEYV-S12	28	2
VED200L15.0R10-04S12	●	●	4	30°	20	18.3	15	1	S12	25.5	KEYV-S12	28	2
VED200L15.0R20-04S12		●	4	30°	20	18.3	15	2	S12	25.5	KEYV-S12	28	2
VED200L15.0R30-04S12		●	4	30°	20	18.3	15	3	S12	25.5	KEYV-S12	28	2

* Recommended clamping torque (N-m)

**Fig. 1: Avoid interference with workpiece when using this cutting head. The shank diameter is larger than the cutter diameter when assembled.

2 pieces per package

● : New product

● : Line up

VEE**-I...

4 flute, roughing - finishing, variable pitch

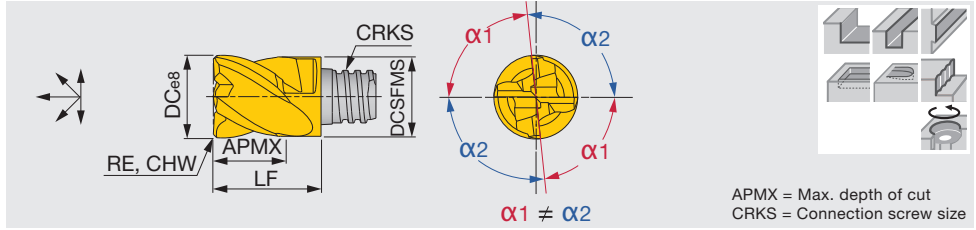

Designation	AH715	AH725	NOF	FHA	DC	DCSFMS	APMX	RE	CHW	CRKS	LF	Wrench	Torque*
VEE080L05.0C30I04S05	●	●	4	38°	8	7.7	5	-	0.3	S05	10	KEYV-S05	7
VEE100L07.0C40I04S06	●	●	4	38°	10	9.7	7	-	0.4	S06	13	KEYV-S06	10
VEE120L09.0C50I04S08	●	●	4	38°	12	11.7	9	-	0.5	S08	16.5	KEYV-S08	15
VEE160L12.0C60I04S10	●	●	4	38°	16	15.3	12	-	0.6	S10	20.5	KEYV-S10	28
VEE200L15.0C60I04S12	●	●	4	38°	20	18.3	15	-	0.6	S12	25.5	KEYV-S12	28
VEE250L22.0C60I04S15	●	●	4	38°	25	23.9	22	-	0.6	S15	37	KEYV-W20	40
VEE250L22.0R00I04S15	●	●	4	38°	25	23.9	22	-	-	S15	37	KEYV-W20	40
VEE250L22.0R05I04S15	●	●	4	38°	25	23.9	22	0.5	-	S15	37	KEYV-W20	40
VEE250L22.0R10I04S15	●	●	4	38°	25	23.9	22	1	-	S15	37	KEYV-W20	40
VEE250L22.0R20I04S15	●	●	4	38°	25	23.9	22	2	-	S15	37	KEYV-W20	40
VEE250L22.0R30I04S15	●	●	4	38°	25	23.9	22	3	-	S15	37	KEYV-W20	40

* Recommended clamping torque (N-m)
VEE080 - VEE200: 2 pieces per package
VEE250: 1 piece per package

● : New product
● : Line up

VEE**-03...

3 flute, roughing - finishing, general, for key way

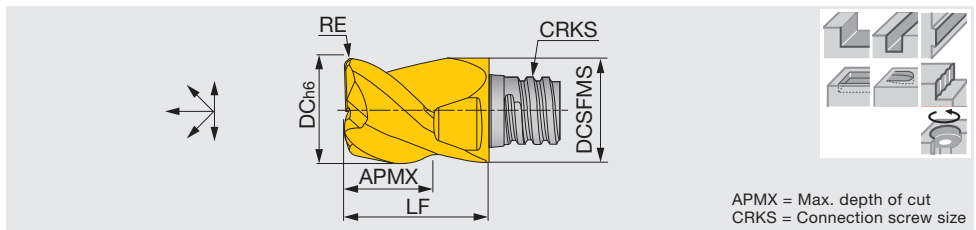

Designation	AH715	AH725	NOF	FHA	DC	DCSFMS	APMX	RE	CHW	CRKS	LF	Wrench	Torque*
VEE077L04.0R02-03S05	●	●	3	38°	7.7	7.7	4	0.2	-	S05	10	KEYV-S05	7
VEE080L05.0R00-03S05	●	●	3	45°	8	7.7	5	-	-	S05	10	KEYV-S05	7
VEE097L05.0R03-03S06	●	●	3	38°	9.7	9.7	5	0.3	-	S06	13	KEYV-S06	10
VEE100L07.0R00-03S06	●	●	3	45°	10	9.7	7	-	-	S06	13	KEYV-S06	10
VEE117L07.0R03-03S08	●	●	3	38°	11.7	11.7	7	0.3	-	S08	16.5	KEYV-S08	15
VEE120L09.0R00-03S08	●	●	3	45°	12	11.7	9	-	-	S08	16.5	KEYV-S08	15
VEE157L08.0R03-03S10	●	●	3	38°	15.7	15.3	8	0.3	-	S10	20.5	KEYV-S10	28
VEE197L12.0R04-03S12	●	●	3	38°	19.7	18.3	12	0.4	-	S12	25.5	KEYV-S12	28

* Recommended clamping torque (N-m)
2 pieces per package

● : New product
● : Line up

VEE**A02...

2 flute, roughing - finishing, for non-ferrous metal, general

Square

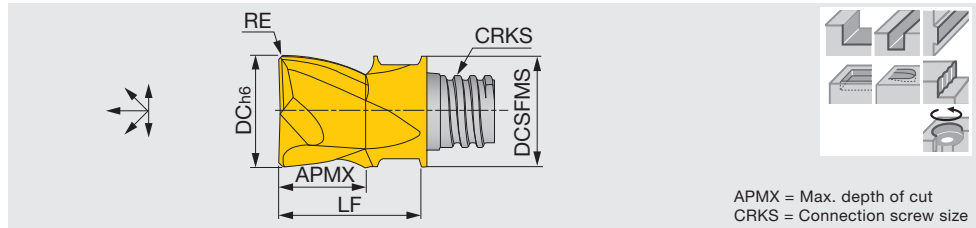

Designation	KS15F	NOF	FHA	DC	DCSFMS	APMX	RE	CRKS	LF	Wrench	Torque*
VEE100L07.0R05A02S06	●	2	45°	10	9.7	7	0.5	S06	13	KEYV-S06	10
VEE100L07.0R10A02S06	●	2	45°	10	9.7	7	1	S06	13	KEYV-S06	10
VEE120L09.0R05A02S08	●	2	45°	12	11.7	9	0.5	S08	16.5	KEYV-S08	15

* Recommended clamping torque (N·m)
2 pieces per package

● : Line up

VEE**A03...

3 flute, roughing - finishing, for non-ferrous metal, general

Square

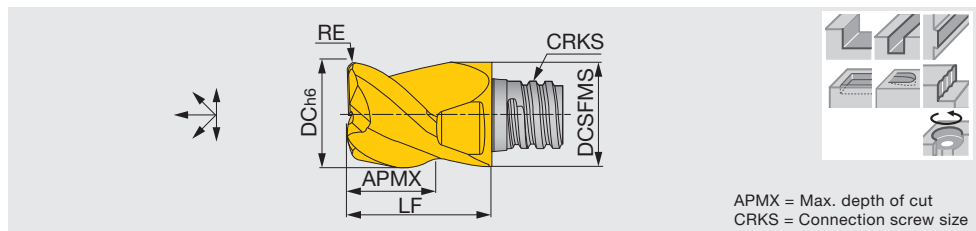

Designation	KS15F	NOF	FHA	DC	DCSFMS	APMX	RE	CRKS	LF	Wrench	Torque*
VEE080L05.0R05A03S05	●	3	45°	8	7.7	5	0.5	S05	10	KEYV-S05	7
VEE100L06.0R05A03S06	●	3	45°	10	9.7	6	0.5	S06	13	KEYV-S06	10
VEE100L06.0R10A03S06	●	3	45°	10	9.7	6	1	S06	13	KEYV-S06	10
VEE120L08.0R05A03S08	●	3	45°	12	11.7	8	0.5	S08	16.5	KEYV-S08	15
VEE120L08.0R10A03S08	●	3	45°	12	11.7	8	1	S08	16.5	KEYV-S08	15
VEE160L10.0R00A03S10	●	3	45°	16	15.3	10	-	S10	20.5	KEYV-S10	28
VEE160L10.0R10A03S10	●	3	45°	16	15.3	10	1	S10	20.5	KEYV-S10	28
VEE160L10.0R20A03S10	●	3	45°	16	15.3	10	2	S10	20.5	KEYV-S10	28
VEE200L12.0R05A03S12	●	3	45°	20	18.3	12	0.5	S12	25.5	KEYV-S12	28
VEE200L12.0R10A03S12	●	3	45°	20	18.3	12	1	S12	25.5	KEYV-S12	28
VEE200L12.0R20A03S12	●	3	45°	20	18.3	12	2	S12	25.5	KEYV-S12	28

* Recommended clamping torque (N·m)
2 pieces per package

● : Line up

VEE**R...

4, 5, 6 flute, roughing, serrated cutting edge

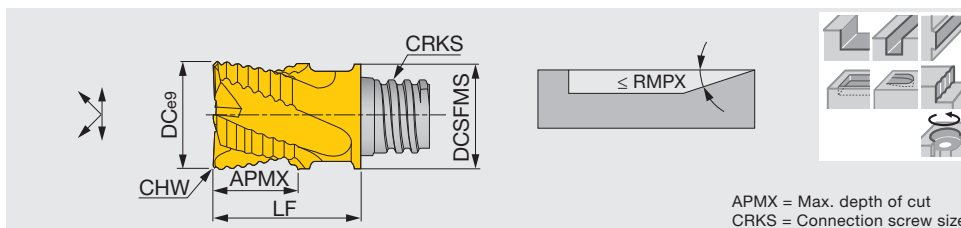

Designation	AH715	AH725	NOF	FHA	DC	DCSFMS	APMX	CHW	CRKS	LF	RMPX	Wrench	Torque*
VEE080L05.0C25R04S05	●		4	45°	8	7.7	5	0.25	S05	10	5°	KEYV-S05	7
VEE100L07.0C30R04S06		●	4	45°	10	9.7	7	0.3	S06	13	5°	KEYV-S06	10
VEE120L09.0C35R04S08	●	●	4	45°	12	11.7	9	0.35	S08	16.5	5°	KEYV-S08	15
VEE160L12.0C40R05S10	●	●	5	45°	16	15.3	12	0.4	S10	20.5	5°	KEYV-S10	28
VEE200L15.0C40R06S12		●	6	45°	20	18.3	15	0.4	S12	25.5	3°	KEYV-S12	28
VEE250L22.0C50R06S15		●	6	45°	25	23.9	22	0.5	S15	37	3°	KEYV-W20	40

* Recommended clamping torque (N-m)
VEE080 - VEE200: 2 pieces per package
VEE250: 1 piece per package

● : Line up

VED**R...

4, 5, 6 flute, roughing, long cutting edge, serrated cutting edge

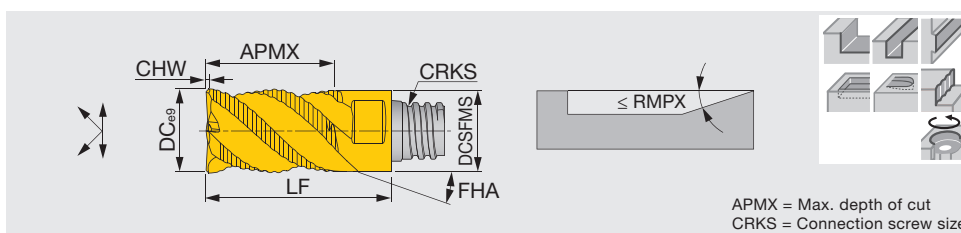

Designation	AH725	NOF	FHA	DC	DCSFMS	APMX	CHW	CRKS	LF	RMPX	Wrench	Torque*
VED080L12.0C25R04S05	●	4	47°	8	7.7	12	0.25	S05	18	5°	KEYV-S05	7
VED100L15.0C30R04S06	●	4	47°	10	9.6	15	0.3	S06	22	5°	KEYV-S06	10
VED120L18.0C35R04S08	●	4	47°	12	11.7	18	0.35	S08	27	5°	KEYV-S08	15
VED160L24.0C40R05S10	●	5	47°	16	15.3	24	0.4	S10	33.5	5°	KEYV-S10	28
VED200L30.0C40R06S12	●	6	47°	20	18.45	30	0.4	S12	41	3°	KEYV-S12	28
VED250L37.0C50I06S15	●	6	47°	25	23.9	37	0.5	S15	52.5	3°	KEYV-W20	40

* Recommended clamping torque (N-m)
VED080 - VED160: 2 pieces per package
VED200, VED250: 1 piece per package

● : New product

VEE**C...

4 flute, roughing - semi finishing, roughing and finishing edge combination

Square

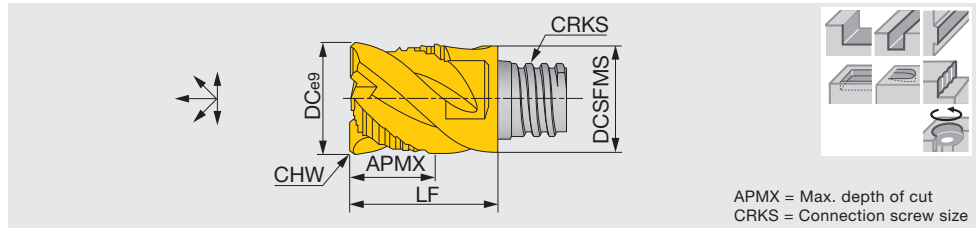

APMX = Max. depth of cut
CRKS = Connection screw size

Designation	AH725	NOF	FHA	DC	DCSFMS	APMX	CHW	CRKS	LF	Wrench	Torque*
VEE080L05.0C30C04S05	●	4	45°	8	7.7	5	0.3	S05	10	KEYV-S05	7
VEE100L07.0C30C04S06	●	4	45°	10	9.7	7	0.3	S06	13	KEYV-S06	10
VEE120L09.0C40C04S08	●	4	45°	12	11.7	9	0.4	S08	16.5	KEYV-S08	15
VEE160L12.0C60C04S10	●	4	45°	16	15.3	12	0.6	S10	20.5	KEYV-S10	28
VEE200L15.0C60C04S12	●	4	45°	20	18.3	15	0.6	S12	25.5	KEYV-S12	28
VEE250L22.0C60C04S15	●	4	45°	25	23.9	22	0.6	S15	37	KEYV-W20	40

* Recommended clamping torque (N·m)
VEE080 – VEE200: 2 pieces per package
VEE250: 1 piece per package

● : Line up

VED**-06..., VEE**-06...

6 flute, roughing - finishing, small width of cut

Square

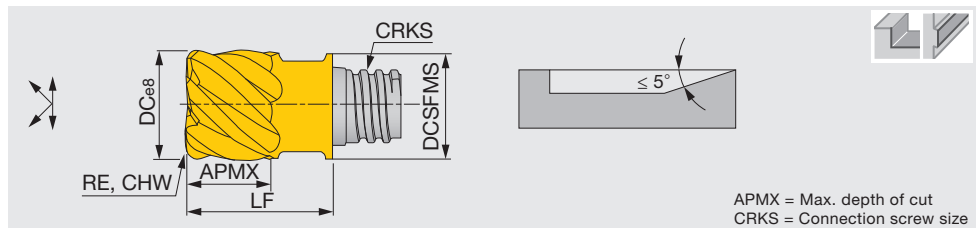

APMX = Max. depth of cut
CRKS = Connection screw size

Designation	AH725	AH750	NOF	FHA	DC	DCSFMS	APMX	RE	CHW	CRKS	LF	Wrench	Torque*
VEE080L05.0R05-06S05	●		6	45°	8	7.7	5	0.5	-	S05	10	KEYV-S05	7
VEE080L05.0R10-06S05	●		6	45°	8	7.7	5	1	-	S05	10	KEYV-S05	7
VEE080L05.0R15-06S05	●		6	45°	8	7.7	5	1.5	-	S05	10	KEYV-S05	7
VEE080L05.0C10-06S05		●	6	50°	8	7.7	5	-	0.1	S05	10	KEYV-S05	7
VEE100L07.0R00-06S06	●		6	45°	10	9.7	7	-	-	S06	13	KEYV-S06	10
VED100L07.0R05-06S06	●		6	30°	10	9.7	7	0.5	-	S06	13	KEYV-S06	10
VEE100L07.0R05-06S06	●		6	45°	10	9.7	7	0.5	-	S06	13	KEYV-S06	10
VED100L07.0R10-06S06	●		6	30°	10	9.7	7	1	-	S06	13	KEYV-S06	10
VEE100L07.0R10-06S06	●		6	45°	10	9.7	7	1	-	S06	13	KEYV-S06	10
VED100L07.0R15-06S06	●		6	30°	10	9.7	7	1.5	-	S06	13	KEYV-S06	10
VEE100L07.0R15-06S06	●		6	45°	10	9.7	7	1.5	-	S06	13	KEYV-S06	10
VEE100L07.0C10-06S06		●	6	50°	10	9.7	7	-	0.1	S06	13	KEYV-S06	10
VEE120L09.0R00-06S08	●		6	45°	12	11.7	9	-	-	S08	16.5	KEYV-S08	15
VED120L09.0R05-06S08	●		6	30°	12	11.7	9	0.5	-	S08	16.5	KEYV-S08	15
VED120L09.0R10-06S08	●		6	30°	12	11.7	9	1	-	S08	16.5	KEYV-S08	15
VEE120L09.0R10-06S08	●		6	45°	12	11.7	9	1	-	S08	16.5	KEYV-S08	15
VEE120L09.0R15-06S08	●		6	45°	12	11.7	9	1.5	-	S08	16.5	KEYV-S08	15
VEE120L09.0C10-06S08		●	6	50°	12	11.7	9	-	0.1	S08	16.5	KEYV-S08	15

* Recommended clamping torque (N·m)
2 pieces per package

● : Line up

VED**-08/10..., VEE**-08/10...

8, 10 flute, roughing - finishing, small width of cut

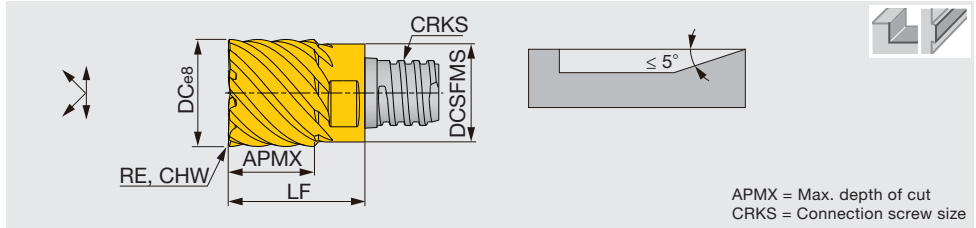

Designation	AH715	AH725	AH750	NOF	FHA	DC	DCSFMS	APMX	RE	CHW	CRKS	LF	Wrench	Torque*
VED160L12.0R05-08S10		●		8	30°	16	15.3	12	0.5	-	S10	20.5	KEYV-S10	28
VED160L12.0R10-08S10	●	●		8	30°	16	15.3	12	1	-	S10	20.5	KEYV-S10	28
VED160L12.0R16-08S10		●		8	30°	16	15.3	12	1.6	-	S10	20.5	KEYV-S10	28
VED160L12.0R20-08S10		●		8	30°	16	15.3	12	2	-	S10	20.5	KEYV-S10	28
VEE160L12.0C20-08S10			●	8	50°	16	15.3	12	-	0.2	S10	20.5	KEYV-S10	28
VED200L15.0R10-10S12		●		10	30°	20	18.3	15	1	-	S12	25.5	KEYV-S12	28
VED200L15.0R20-10S12		●		10	30°	20	18.3	15	2	-	S12	25.5	KEYV-S12	28
VEE200L15.0C20-10S12			●	10	50°	20	18.3	15	-	0.2	S12	25.5	KEYV-S12	28
VED250L22.0R10-10S15		●		10	30°	25	23.9	22	1	-	S15	37	KEYV-W20	40
VED250L22.0R20-10S15		●		10	30°	25	23.9	22	2	-	S15	37	KEYV-W20	40

* Recommended clamping torque (N·m)
VEE / VED160 - 200: 2 pieces per package
VED250: 1 piece per package

● : Line up

VED**-07/09...

7, 9 flute, roughing - finishing, long edge, variable helix and pitch, small width of cut

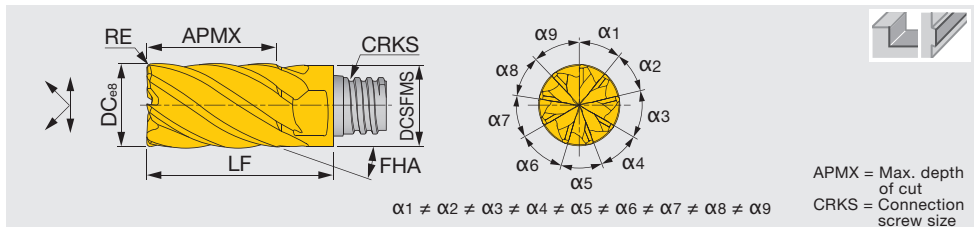

Designation	AH725	NOF	FHA	DC	DCSFMS	APMX	RE	CRKS	LF	Wrench	Torque*
VED080L12.0R05I07S05	●	7	34° - 40°	8	7.7	12	0.5	S05	18	KEYV-S05	7
VED100L15.0R05I07S06	●	7	34° - 40°	10	9.6	15	0.5	S06	22	KEYV-S06	10
VED120L18.0R05I07S08	●	7	34° - 40°	12	11.7	18	0.5	S08	27	KEYV-S08	15
VED160L24.0R08I09S10	●	9	34° - 40°	16	15.3	24	0.8	S10	33.5	KEYV-S10	28
VED200L30.0R10I09S12	●	9	34° - 40°	20	18.45	30	1	S12	41	KEYV-S12	28
VED250L37.0R10I09S15	●	9	34° - 40°	25	23.9	37	1	S15	52.5	KEYV-W20	40

* Recommended clamping torque (N·m)
VED080 - VED160: 2 pieces per package
VED200, VED250: 1 piece per package

● : New product

STANDARD CUTTING CONDITIONS

Shoulder milling

VEH, VEE: 3 flutes, VED / VEE: 4 flutes, VEE-A, VEE-I, VEE-R, VED-R, VEE-C

ISO	Workpiece material	Hardness	Cutting speed Vc (m/min)	Feed per tooth: fz (mm/t)									Depth of cut ap (mm)	Width of cut ae (mm)
				Tool diameter: DC (mm)										
				5	6	8	10	12	16	20	25	32		
P	Carbon steel S45C, S55C, etc. C45, C55, etc.	- 300 HB	80 - 180	0.03 - 0.07	0.03 - 0.07	0.05 - 0.09	0.07 - 0.12	0.08 - 0.13	0.09 - 0.15	0.1 - 0.17	0.1 - 0.17	0.1 - 0.18	0.6 x DC	0.25 x DC
	Alloy steel SCM440, SCr420, etc. 42CrMo4, 20Cr4, etc.	- 300 HB	60 - 140	0.03 - 0.07	0.03 - 0.07	0.05 - 0.09	0.07 - 0.12	0.08 - 0.13	0.09 - 0.15	0.1 - 0.17	0.1 - 0.17	0.1 - 0.18	0.6 x DC	0.25 x DC
	Prehardened steel PX5, NAK80, etc.	30 - 40 HRC	60 - 120	0.03 - 0.07	0.03 - 0.07	0.05 - 0.09	0.07 - 0.12	0.08 - 0.13	0.09 - 0.15	0.1 - 0.17	0.1 - 0.17	0.1 - 0.18	0.6 x DC	0.25 x DC
M	Stainless steel SUS304, SUS316, etc. X5CrNi18-9, X5CrNiMo17-12-2, etc.	- 200 HB	40 - 100	0.03 - 0.07	0.03 - 0.07	0.05 - 0.09	0.07 - 0.12	0.08 - 0.13	0.09 - 0.15	0.1 - 0.17	0.1 - 0.17	0.1 - 0.18	0.6 x DC	0.25 x DC
K	Grey cast iron FC250, FC300, etc. 250, 300, etc., GG250, GG300, etc.	150 - 250 HB	80 - 200	0.03 - 0.07	0.03 - 0.07	0.05 - 0.09	0.07 - 0.12	0.08 - 0.13	0.09 - 0.15	0.1 - 0.17	0.1 - 0.17	0.1 - 0.18	0.6 x DC	0.25 x DC
	Ductile cast iron FCD450, etc. 450-10S, etc., GGG450, etc.	150 - 250 HB	80 - 200	0.03 - 0.07	0.03 - 0.07	0.05 - 0.09	0.07 - 0.12	0.08 - 0.13	0.09 - 0.15	0.1 - 0.17	0.1 - 0.17	0.1 - 0.18	0.6 x DC	0.25 x DC
N	Aluminium alloys Si < 13%	-	200 - 700	0.03 - 0.07	0.03 - 0.07	0.05 - 0.09	0.07 - 0.12	0.08 - 0.13	0.09 - 0.15	0.1 - 0.17	0.1 - 0.17	0.1 - 0.18	0.6 x DC	0.25 x DC
	Aluminium alloys Si ≥ 13%	-	100 - 300	0.03 - 0.07	0.03 - 0.07	0.05 - 0.09	0.07 - 0.12	0.08 - 0.13	0.09 - 0.15	0.1 - 0.17	0.1 - 0.17	0.1 - 0.18	0.6 x DC	0.25 x DC
S	Titanium alloys Ti-6Al-4V, etc.	-	40 - 80	0.03 - 0.07	0.03 - 0.07	0.05 - 0.09	0.07 - 0.12	0.08 - 0.13	0.09 - 0.15	0.1 - 0.17	0.1 - 0.17	0.1 - 0.18	0.6 x DC	0.25 x DC
	Heat-resistant alloys Inconel 718, etc.	-	20 - 40	0.03 - 0.07	0.03 - 0.07	0.05 - 0.09	0.07 - 0.12	0.08 - 0.13	0.09 - 0.15	0.1 - 0.17	0.1 - 0.17	0.1 - 0.18	0.6 x DC	0.25 x DC
H	Hardened steel SKD6, SKT4, etc. 55NiCrMoV7, etc.	40 - 50 HRC	40 - 80	0.03 - 0.07	0.03 - 0.07	0.05 - 0.09	0.07 - 0.12	0.08 - 0.13	0.09 - 0.15	0.1 - 0.17	0.1 - 0.17	0.1 - 0.18	0.6 x DC	0.25 x DC
	Hardened steel SKD11, SKH51, etc. HS6-5-2, etc.	50 - 60 HRC	20 - 60	0.03 - 0.07	0.03 - 0.07	0.05 - 0.09	0.07 - 0.12	0.08 - 0.13	0.09 - 0.15	0.1 - 0.17	0.1 - 0.17	0.1 - 0.18	0.6 x DC	0.25 x DC

VED / VEE: 6 flutes, VED / VEE: 8, 10 flutes, VED: 7, 9 flutes

ISO	Workpiece material	Hardness	Cutting speed Vc (m/min)	Feed per tooth: fz (mm/t)						Depth of cut ap (mm)	Width of cut ae (mm)
				Tool diameter: DC (mm)							
				8	10	12	16	20	25		
S	Titanium alloys Ti-6Al-4V, etc.	-	60 - 120	0.05 - 0.09	0.07 - 0.12	0.08 - 0.13	0.09 - 0.15	0.1 - 0.17	0.1 - 0.17	0.6 x DC	0.02 x DC
	Heat-resistant alloys Inconel 718, etc.	-	30 - 60	0.05 - 0.09	0.07 - 0.12	0.08 - 0.13	0.09 - 0.15	0.1 - 0.17	0.1 - 0.17	0.6 x DC	0.02 x DC
H	Hardened steel SKD6, SKT4, etc. 55NiCrMoV7, etc.	40 - 50 HRC	80 - 160	0.05 - 0.09	0.07 - 0.12	0.08 - 0.13	0.09 - 0.15	0.1 - 0.17	0.1 - 0.17	0.6 x DC	0.02 x DC
	Hardened steel SKD11, SKH51, etc. HS6-5-2, etc.	50 - 60 HRC	40 - 90	0.05 - 0.09	0.07 - 0.12	0.08 - 0.13	0.09 - 0.15	0.1 - 0.17	0.1 - 0.17	0.6 x DC	0.02 x DC

Slotting

VEH, VEE: 3 flutes, VED/VEE: 4 flutes, VEE-A, VEE-I, VEE-R, VEE-C

ISO	Workpiece material	Hardness	Cutting speed V _c (m/min)	Feed per tooth: fz (mm/t)									Depth of cut a _p (mm)
				Tool diameter: DC (mm)									
				5	6	8	10	12	16	20	25	32	
P	Carbon steel S45C, S55C, etc. C45, C55, etc.	- 300 HB	50 - 70	0.03 - 0.04	0.03 - 0.04	0.03 - 0.04	0.04 - 0.05	0.05 - 0.06	0.06 - 0.08	0.07 - 0.1	0.07 - 0.1	0.07 - 0.1	0.5 x DC
	Alloy steel SCM440, SCr420, etc. 42CrMo4, 20Cr4, etc.	- 300 HB	40 - 80	0.03 - 0.04	0.03 - 0.04	0.03 - 0.04	0.04 - 0.05	0.05 - 0.06	0.06 - 0.08	0.07 - 0.1	0.07 - 0.1	0.07 - 0.1	0.5 x DC
	Prehardened steel PX5, NAK80, etc.	30 - 40 HRC	40 - 70	0.03 - 0.04	0.03 - 0.04	0.03 - 0.04	0.04 - 0.05	0.05 - 0.06	0.06 - 0.08	0.07 - 0.1	0.07 - 0.1	0.07 - 0.1	0.5 x DC
M	Stainless steel SUS304, SUS316, etc. X5CrNi18-9, X5CrNiMo17-12-2, etc.	- 200 HB	30 - 60	0.03 - 0.04	0.03 - 0.04	0.03 - 0.04	0.04 - 0.05	0.05 - 0.06	0.06 - 0.08	0.07 - 0.1	0.07 - 0.1	0.07 - 0.1	0.5 x DC
K	Grey cast iron FC250, FC300, etc. 250, 300, etc., GG250, GG300, etc.	150 - 250 HB	50 - 120	0.03 - 0.04	0.03 - 0.04	0.03 - 0.04	0.04 - 0.05	0.05 - 0.06	0.06 - 0.08	0.07 - 0.1	0.07 - 0.1	0.07 - 0.1	0.5 x DC
	Ductile cast iron FCD450, etc. 450-10S, etc., GGG450, etc.	150 - 250 HB	50 - 120	0.03 - 0.04	0.03 - 0.04	0.03 - 0.04	0.04 - 0.05	0.05 - 0.06	0.06 - 0.08	0.07 - 0.1	0.07 - 0.1	0.07 - 0.1	0.5 x DC
N	Aluminium alloys Si < 13%	-	130 - 400	0.03 - 0.04	0.03 - 0.04	0.03 - 0.04	0.04 - 0.05	0.05 - 0.06	0.06 - 0.08	0.07 - 0.1	0.07 - 0.1	0.07 - 0.1	0.5 x DC
	Aluminium alloys Si ≥ 13%	-	70 - 200	0.03 - 0.04	0.03 - 0.04	0.03 - 0.04	0.04 - 0.05	0.05 - 0.06	0.06 - 0.08	0.07 - 0.1	0.07 - 0.1	0.07 - 0.1	0.5 x DC
S	Titanium alloys Ti-6Al-4V, etc.	-	20 - 40	0.03 - 0.04	0.03 - 0.04	0.03 - 0.04	0.04 - 0.05	0.05 - 0.06	0.06 - 0.08	0.07 - 0.1	0.07 - 0.1	0.07 - 0.1	0.5 x DC
	Heat-resistant alloys Inconel 718, etc.	-	10 - 20	0.03 - 0.04	0.03 - 0.04	0.03 - 0.04	0.04 - 0.05	0.05 - 0.06	0.06 - 0.08	0.07 - 0.1	0.07 - 0.1	0.07 - 0.1	0.5 x DC
H	Hardened steel SKD6, SKT4, etc. 55NiCrMoV7, etc.	40 - 50 HRC	25 - 60	0.03 - 0.04	0.03 - 0.04	0.03 - 0.04	0.04 - 0.05	0.05 - 0.06	0.06 - 0.08	0.07 - 0.1	0.07 - 0.1	0.07 - 0.1	0.5 x DC
	Hardened steel SKD11, SKH51, etc. HS6-5-2, etc.	50 - 60 HRC	10 - 30	0.03 - 0.04	0.03 - 0.04	0.03 - 0.04	0.04 - 0.05	0.05 - 0.06	0.06 - 0.08	0.07 - 0.1	0.07 - 0.1	0.07 - 0.1	0.5 x DC

HEADS

VFM...

6 flute, roughing - finishing, for face milling

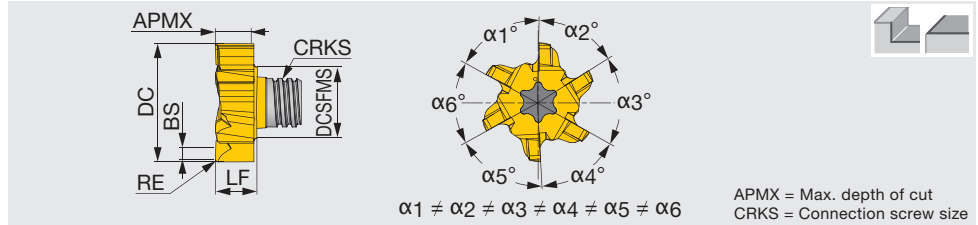

APMX = Max. depth of cut
CRKS = Connection screw size

Designation	AH715	NOF	FHA	DC	DCSFMS	APMX	RE	BS	CRKS	LF	Wrench	Torque*
VFM120L03.6R02I06S05	●	6	10°	12	7.7	3.6	0.2	1.2	S05	4.4	KEYV-T20	7
VFM160L04.8R04I06S06	●	6	10°	16	9.7	4.8	0.4	2	S06	5.6	KEYV-T25	10
VFM200L06.0R04I06S08	●	6	10°	20	11.7	6	0.4	2	S08	7	KEYV-T40L	15
VFM250L07.5R04I06S10	●	6	10°	25	15.3	7.5	0.4	2	S10	8.55	KEYV-T50L	28

* Recommended clamping torque (N-m)
2 pieces per package

● : New product
● : Line up

STANDARD CUTTING CONDITIONS

Face milling

VFM

ISO	Workpiece material	Hardness	Cutting speed V _c (m/min)	Feed per tooth: fz (mm/t)				Depth of cut ap (mm)	Width of cut ae (mm)
				Tool diameter: DC (mm)					
				12	16	20	25		
P	Carbon steel S45C, S55C, etc. C45, C55, etc.	- 300 HB	80 - 180	0.08 - 0.13	0.09 - 0.15	0.1 - 0.17	0.1 - 0.17	1	0.7 x DC
	Alloy steel SCM440, SCr420, etc. 42CrMo4, 20Cr4, etc.	- 300 HB	60 - 140	0.08 - 0.13	0.09 - 0.15	0.1 - 0.17	0.1 - 0.17	1	0.7 x DC
	Prehardened steel PX5, NAK80, etc.	30 - 40 HRC	60 - 120	0.08 - 0.13	0.09 - 0.15	0.1 - 0.17	0.1 - 0.17	1	0.7 x DC
M	Stainless steel SUS304, SUS316, etc. X5CrNi18-9, X5CrNiMo17-12-2, etc.	- 200 HB	40 - 100	0.08 - 0.13	0.09 - 0.15	0.1 - 0.17	0.1 - 0.17	1	0.7 x DC
K	Grey cast iron FC250, FC300, etc. 250, 300, etc., GG250, GG300, etc.	150 - 250 HB	80 - 200	0.08 - 0.13	0.09 - 0.15	0.1 - 0.17	0.1 - 0.17	1	0.7 x DC
	Ductile cast iron FCD450, etc. 450-10S, etc., GGG450, etc.	150 - 250 HB	80 - 200	0.08 - 0.13	0.09 - 0.15	0.1 - 0.17	0.1 - 0.17	1	0.7 x DC
N	Aluminium alloys Si < 13%	-	200 - 700	0.08 - 0.13	0.09 - 0.15	0.1 - 0.17	0.1 - 0.17	1	0.7 x DC
	Aluminium alloys Si ≥ 13%	-	100 - 300	0.08 - 0.13	0.09 - 0.15	0.1 - 0.17	0.1 - 0.17	1	0.7 x DC
S	Titanium alloys Ti-6Al-4V, etc.	-	40 - 80	0.08 - 0.13	0.09 - 0.15	0.1 - 0.17	0.1 - 0.17	1	0.7 x DC
	Heat-resistant alloys Inconel 718, etc.	-	20 - 40	0.08 - 0.13	0.09 - 0.15	0.1 - 0.17	0.1 - 0.17	1	0.7 x DC
H	Hardened steel SKD6, SKT4, etc. 55NiCrMoV7, etc.	40 - 50 HRC	40 - 80	0.08 - 0.13	0.09 - 0.15	0.1 - 0.17	0.1 - 0.17	1	0.7 x DC
	Hardened steel SKD11, SKH51, etc. HS6-5-2, etc.	50 - 60 HRC	20 - 60	0.08 - 0.13	0.09 - 0.15	0.1 - 0.17	0.1 - 0.17	1	0.7 x DC

HEADS

VFX**-02...

2 flute, roughing

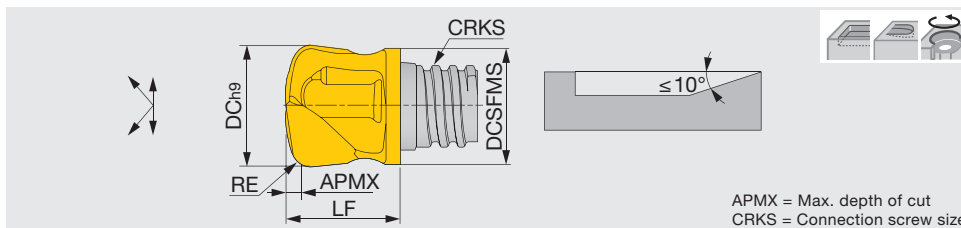

Designation	AH725	NOF	FHA	DC	DCSFMS	APMX	RE ⁽¹⁾	CRKS	LF	Wrench	Torque*	fz(mm/t)
VFX100L00.6R20-02S06	●	2	0°	10	9.6	0.6	2	S06	12.5	KEYV-S06	10	0.3 - 0.6
VFX120L01.0R25-02S08	●	2	0°	12	11.5	1.0	2.5	S08	11.1	KEYV-S08	15	0.5 - 1
VFX160L01.1R30-02S10	●	2	0°	16	15.2	1.1	3	S10	13.5	KEYV-S10	28	0.55 - 1.1
VFX200L01.5R33-02S12	●	2	0°	20	18.3	1.5	3.3	S12	17.5	KEYV-S12	28	0.75 - 1.5

(1) Corner radius for CAM programming

For VFX head, taper neck shank or Tungsten shank should be recommended.

* Recommended clamping torque (N·m)

2 pieces per package

● : Line up

VFX**-04/06...

4, 6 flute, roughing, with coolant hole (2 items does not have coolant hole)

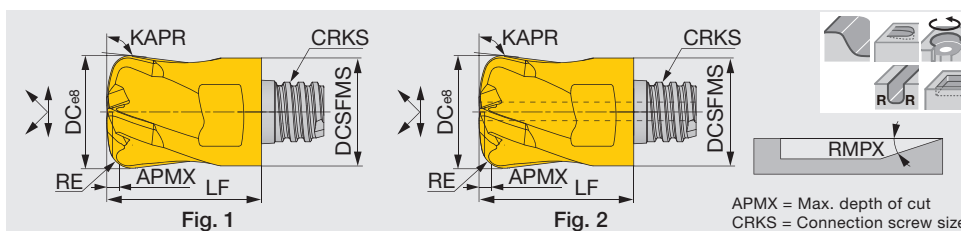

Designation	AH715	AH725	AH750	NOF	FHA	DC	DCSFMS	APMX	RE	KAPR	CRKS	LF	RMPX	Wrench	Torque*	fz(mm/t)	Fig.
VFX120L0.60R18E04S08	●			4	20°	12	11.5	0.6	1.8	97°	S08	16.5	5°	KEYV-S08	15	0.16 - 0.67	2
VFX120L0.60R18H04S08		●		4	20°	12	11.5	0.6	1.8	97°	S08	16.5	5°	KEYV-S08	15	0.16 - 0.67	1
VFX120L0.65R12E06S08			●	6	20°	12	11.5	0.65	0.6	97°	S08	12	3°	KEYV-S08	15	0.16 - 0.54	2
VFX160L0.80R22E04S10	●			4	20°	16	15.4	0.8	2.2	97°	S10	20.5	5°	KEYV-S10	28	0.2 - 0.75	2
VFX160L0.80R22H04S10		●		4	20°	16	15.4	0.8	2.2	97°	S10	20.5	5°	KEYV-S10	28	0.2 - 0.75	1
VFX160L1.05R20E06S10			●	6	20°	16	15.4	1.05	1	97°	S10	16	3°	KEYV-S10	28	0.2 - 0.65	2

We don't recommend slot milling. Also max. ae < 0.4D.

* Recommended clamping torque (N·m)

2 pieces per package

● : New product

● : Line up

STANDARD CUTTING CONDITIONS

High feed milling

VFX: 2, 4, 6 flutes

ISO	Workpiece material	Hardness	Cutting speed Vc (m/min)	ø10		ø12		ø16		ø20		Width of cut ae (mm)
				Feed per tooth fz (mm/t)	Depth of cut ap (mm)	Feed per tooth fz (mm/t)	Depth of cut ap (mm)	Feed per tooth fz (mm/t)	Depth of cut ap (mm)	Feed per tooth fz (mm/t)	Depth of cut ap (mm)	
P	Carbon steel S45C, S55C, etc. C45, C55, etc.	- 300 HB	100 - 200	0.3 - 0.7	0.5	0.4 - 0.8	0.5	0.5 - 0.9	0.75	0.6 - 1	1	0.6 x DC
	Alloy steel SCM440, SCr420, etc. 42CrMo4, 20Cr4, etc.	- 300 HB	80 - 180	0.2 - 0.6	0.5	0.3 - 0.7	0.5	0.4 - 0.8	0.75	0.5 - 0.9	1	0.6 x DC
	Prehardened steel PX5, NAK80, etc.	30 - 40 HRC	80 - 160	0.2 - 0.5	0.4	0.2 - 0.5	0.4	0.3 - 0.6	0.5	0.3 - 0.6	0.75	0.6 x DC
M	Stainless steel SUS304, SUS316, etc. X5CrNi18-9, X5CrNiMo17-12-2, etc.	- 200 HB	60 - 100	0.2 - 0.6	0.4	0.2 - 0.6	0.4	0.3 - 0.7	0.5	0.3 - 0.7	0.75	0.6 x DC
K	Grey cast iron FC250, FC300, etc. 250, 300, etc., GG250, GG300, etc.	150 - 250 HB	100 - 220	0.3 - 0.7	0.5	0.4 - 0.8	0.75	0.5 - 0.9	0.75	0.6 - 1	1	0.6 x DC
	Ductile cast iron FCD450, etc. 450-10S, etc., GGG450, etc.	150 - 250 HB	100 - 220	0.2 - 0.6	0.5	0.3 - 0.7	0.75	0.4 - 0.8	0.75	0.5 - 0.9	1	0.6 x DC
S	Titanium alloys Ti-6Al-4V, etc.	-	40 - 80	0.2 - 0.5	0.4	0.2 - 0.5	0.4	0.2 - 0.6	0.5	0.2 - 0.6	0.5	0.25 x DC
	Heat-resistant alloys Inconel 718, etc.	-	20 - 40	0.1 - 0.3	0.3	0.1 - 0.3	0.3	0.1 - 0.3	0.4	0.1 - 0.3	0.4	0.25 x DC
H	Hardened steel SKD6, SKT4, etc. 55NiCrMoV7, etc.	40 - 50 HRC	40 - 80	0.2 - 0.4	0.3	0.2 - 0.4	0.3	0.3 - 0.5	0.4	0.3 - 0.5	0.4	0.45 x DC
	Hardened steel SKD11, SKH51, etc. HS6-5-2, etc.	50 - 60 HRC	20 - 60	0.1 - 0.2	0.2	0.1 - 0.2	0.2	0.1 - 0.3	0.3	0.1 - 0.3	0.3	0.25 x DC

Please note that the feed per tooth should not exceed the maximum feed per tooth for each product.

HEADS

VBB**-BM...

2 flute, roughing - semi finishing, economical

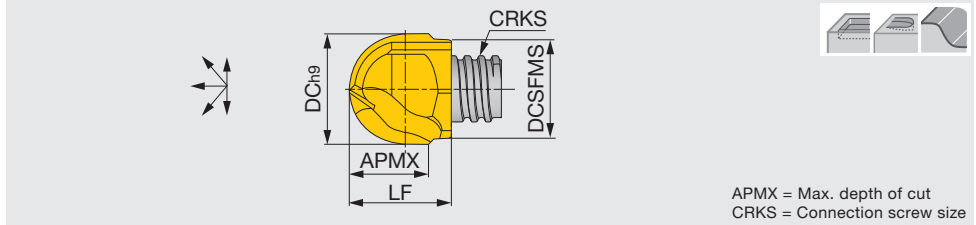

APMX = Max. depth of cut
CRKS = Connection screw size

Designation	AH725	NOF	FHA	DC	DCSFMS	APMX	CRKS	LF	Wrench	Torque*
VBB080L08.0-BM-02S05	●	2	0°	8	7.6	8	S05	10	KEYV-S05	7
VBB100L10.0-BM-02S06	●	2	0°	10	9.5	10	S06	12.4	KEYV-S06	10
VBB120L12.0-BM-02S08	●	2	0°	12	11.5	11.5	S08	15.3	KEYV-S08	15
VBB160L16.0-BM-02S10	●	2	0°	16	15.2	16	S10	19.1	KEYV-S10	28

* Recommended clamping torque (N·m)
2 pieces per package

● : Line up

VBB**-BG...

2 flute, finishing, high accuracy h7, for hardened material

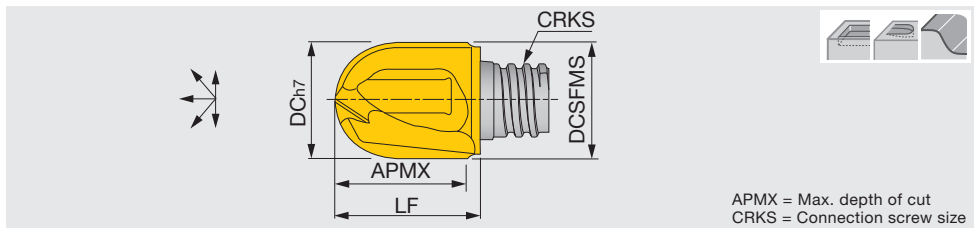

APMX = Max. depth of cut
CRKS = Connection screw size

Designation	AH750	NOF	FHA	DC	DCSFMS	APMX	CRKS	LF	Wrench	Torque*
VBB080L08.0-BG-02S05	●	2	0°	8	7.6	8	S05	10	KEYV-S05	7
VBB100L10.0-BG-02S06	●	2	0°	10	9.6	10	S06	12.4	KEYV-S06	10
VBB120L12.0-BG-02S08	●	2	0°	12	11.5	12	S08	15.3	KEYV-S08	15
VBB160L16.0-BG-02S10	●	2	0°	16	15.2	16	S10	19.1	KEYV-S10	28

* Recommended clamping torque (N·m)
2 pieces per package

● : Line up

VBD**-BG...

2 flute, semi finishing - finishing, helix cutting edge

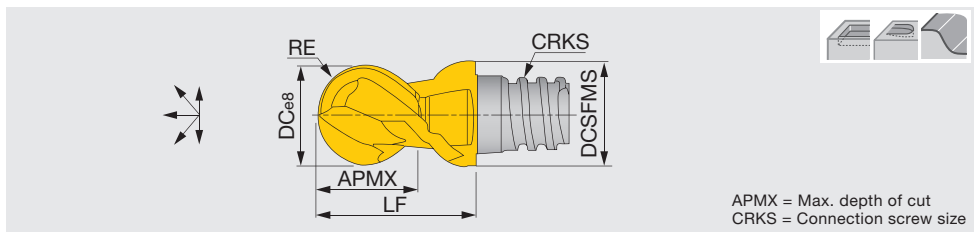

APMX = Max. depth of cut
CRKS = Connection screw size

Designation	AH725	NOF	FHA	DC	DCSFMS	APMX	RE	CRKS	LF	Wrench	Torque*
VBD080L05.0-BG-02S05	●	2	30°	8	7.7	5	3.982 ⁽¹⁾	S05	10	KEYV-S05	7
VBD100L07.0-BG-02S06	●	2	30°	10	9.7	7	4.982 ⁽¹⁾	S06	13	KEYV-S06	10
VBD120L09.0-BG-02S08	●	2	30°	12	11.7	9	5.978 ⁽²⁾	S08	16.5	KEYV-S08	15
VBD160L09.5-BG-02S10	●	2	30°	16	15.3	9	7.978 ⁽²⁾	S10	20.5	KEYV-S10	28

The tolerance of R: (1) ± 0.01 (2) ± 0.012
* Recommended clamping torque (N·m)
2 pieces per package

● : Line up

VBD**-BG-04..., VBE**-BG-04...

4 flute, roughing - finishing, helix cutting edge

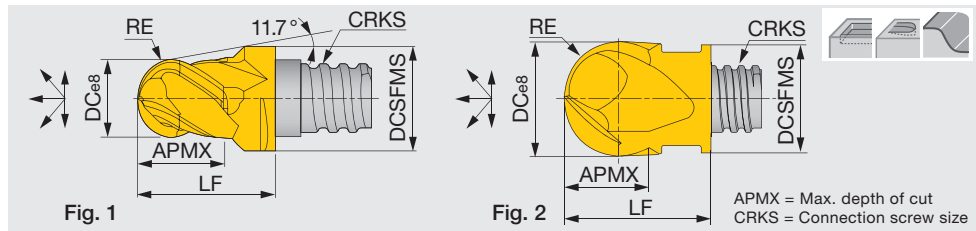

Designation	AH715	AH725	NOF	FHA	DC	DCSFMS	APMX	RE	CRKS	LF	Wrench	Torque*	Fig.
VBE050L04.0-BG-04S04	●	●	4	38°	5	6	4	2.487 ⁽¹⁾	S04	8.5	KEYV-S05	4	1
VBE060L04.0-BG-04S04	●	●	4	38°	6	5.8	4	2.987 ⁽¹⁾	S04	8.5	KEYV-S05	4	2
VBE060L05.5-BG-04S05	●	●	4	38°	6	8	5.5	2.987 ⁽¹⁾	S05	10	KEYV-S05	7	1
VBD080L05.0-BG-04S05	●	●	4	30°	8	7.7	5	3.982 ⁽¹⁾	S05	10	KEYV-S05	7	2
VBD100L07.0-BG-04S06	●	●	4	30°	10	9.7	7	4.982 ⁽¹⁾	S06	13	KEYV-S06	10	2
VBD120L09.0-BG-04S08	●	●	4	30°	12	11.7	9	5.978 ⁽²⁾	S08	16.5	KEYV-S08	15	2
VBD160L12.0-BG-04S10	●	●	4	30°	16	15.3	12	7.978 ⁽²⁾	S10	20.5	KEYV-S10	28	2
VBD200L15.0-BG-04S12	●	●	4	30°	20	18.3	15	9.972 ⁽²⁾	S12	25.5	KEYV-S12	28	2
VBD250L22.0-BG-04S15	●	●	4	30°	25	23.9	22	12.470 ⁽³⁾	S15	37	KEYV-W20	40	2

The tolerance of R: (1) ± 0.01 (2) ± 0.012 (3) ± 0.02

* Recommended clamping torque (N-m)

VBE060/VBD080 ~ VBD200: 2 pieces per package

VBD250: 1 piece per package

● : New product
● : Line up

VBB**-SG...

2 flute, roughing - finishing, sphere cutting edge, high accuracy h7

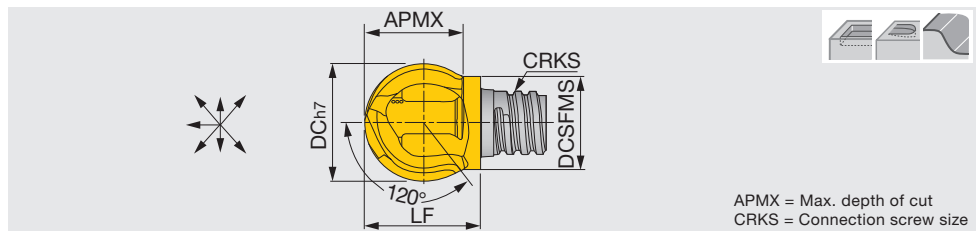

Designation	AH725	NOF	FHA	DC	DCSFMS	APMX	CRKS	LF	Wrench	Torque*
VBB100L08.0-SG-02S05	●	2	0°	10	7.6	7.5	S05	10	KEYV-S05	7
VBB120L09.6-SG-02S06	●	2	0°	12	9.5	9	S06	11.6	***KEYV-S08	10
VBB160L12.9-SG-02S08	●	2	0°	16	12.2	12	S08	15.4	***KEYV-S10	15
VBB200L16.1-SG-02S10	●	2	0°	20	15.2	15	S10	18.4	KEYV-S10	28

For pull-cutting on the vertical wall

* Recommended clamping torque (N-m)

*** The wrench size for these heads is different from the ones for the other head types.

2 pieces per package

● : Line up

VBE**-BGA...

2 flute, roughing - finishing, for non-ferrous metal, helix cutting edge

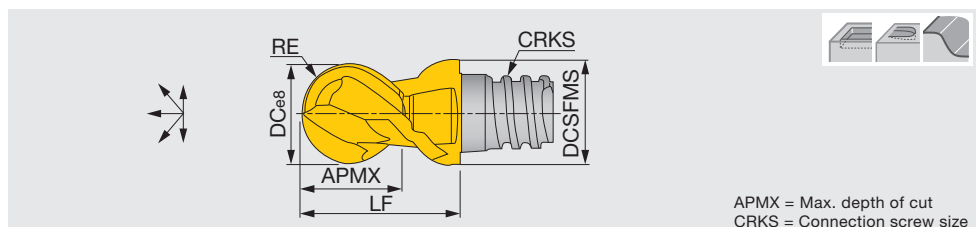

Designation	KS15F	NOF	FHA	DC	DCSFMS	APMX	RE	CRKS	LF	Wrench	Torque*
VBE080L05.0-BGA02S05	●	2	45°	8	7.7	5	3.982 ⁽¹⁾	S05	10	KEYV-S05	7
VBE100L07.0-BGA02S06	●	2	45°	10	9.7	7	4.982 ⁽¹⁾	S06	13	KEYV-S06	10
VBE120L09.0-BGA02S08	●	2	45°	12	11.7	9	5.987 ⁽²⁾	S08	16.5	KEYV-S08	15
VBE160L12.0-BGA02S10	●	2	45°	16	15.3	12	7.978 ⁽²⁾	S10	20.5	KEYV-S10	28
VBE200L15.0-BGA02S12	●	2	45°	20	18.3	15	9.972 ⁽²⁾	S12	25.5	KEYV-S12	28

The tolerance of R: (1) ± 0.01 (2) ± 0.012

* Recommended clamping torque (N-m)

2 pieces per package

● : Line up

STANDARD CUTTING CONDITIONS

Profiling for roughing

VBB-BM / BG / SG, VBD-BG, VBE-BGA

ISO	Workpiece material	Hardness	Cutting speed V_c (m/min)	Feed per tooth: f_z (mm/t)								Depth of cut a_p (mm)	Pick feed P_f (mm)
				Tool diameter: DC (mm)									
				5	6	8	10	12	16	20	25		
P	Carbon steel S45C, S55C, etc. C45, C55, etc.	- 300 HB	100 - 200	0.03 - 0.07	0.03 - 0.07	0.04 - 0.08	0.05 - 0.1	0.06 - 0.11	0.07 - 0.13	0.08 - 0.15	0.08 - 0.15	0.3 x DC	0.4 x DC
	Alloy steel SCM440, SCr420, etc. 42CrMo4, 20Cr4, etc.	- 300 HB	80 - 180	0.03 - 0.07	0.03 - 0.07	0.04 - 0.08	0.05 - 0.1	0.06 - 0.11	0.07 - 0.13	0.08 - 0.15	0.08 - 0.15	0.3 x DC	0.4 x DC
	Prehardened steel PX5, NAK80, etc.	30 - 40 HRC	80 - 160	0.03 - 0.07	0.03 - 0.07	0.04 - 0.08	0.05 - 0.1	0.06 - 0.11	0.07 - 0.13	0.08 - 0.15	0.08 - 0.15	0.3 x DC	0.4 x DC
M	Stainless steel SUS304, SUS316, etc. X5CrNi18-9, X5CrNiMo17-12-2, etc.	- 200 HB	60 - 100	0.03 - 0.07	0.03 - 0.07	0.04 - 0.08	0.05 - 0.1	0.06 - 0.11	0.07 - 0.13	0.08 - 0.15	0.08 - 0.15	0.3 x DC	0.4 x DC
K	Grey cast iron FC250, FC300, etc. 250, 300, etc., GG250, GG300, etc.	150 - 250 HB	100 - 220	0.03 - 0.07	0.03 - 0.07	0.04 - 0.08	0.05 - 0.1	0.06 - 0.11	0.07 - 0.13	0.08 - 0.15	0.08 - 0.15	0.3 x DC	0.4 x DC
	Ductile cast iron FCD450, etc. 450-10S, etc., GGG450, etc.	150 - 250 HB	100 - 220	0.03 - 0.07	0.03 - 0.07	0.04 - 0.08	0.05 - 0.1	0.06 - 0.11	0.07 - 0.13	0.08 - 0.15	0.08 - 0.15	0.3 x DC	0.4 x DC
N	Aluminium alloys Si < 13%	-	200 - 700	0.03 - 0.07	0.03 - 0.07	0.04 - 0.08	0.05 - 0.1	0.06 - 0.11	0.07 - 0.13	0.08 - 0.15	0.08 - 0.15	0.3 x DC	0.4 x DC
	Aluminium alloys Si ≥ 13%	-	100 - 300	0.03 - 0.07	0.03 - 0.07	0.04 - 0.08	0.05 - 0.1	0.06 - 0.11	0.07 - 0.13	0.08 - 0.15	0.08 - 0.15	0.3 x DC	0.4 x DC
S	Titanium alloys Ti-6Al-4V, etc.	-	40 - 80	0.03 - 0.07	0.03 - 0.07	0.04 - 0.08	0.05 - 0.1	0.06 - 0.11	0.07 - 0.13	0.08 - 0.15	0.08 - 0.15	0.3 x DC	0.2 x DC
	Heat-resistant alloys Inconel 718, etc.	-	20 - 40	0.03 - 0.07	0.03 - 0.07	0.04 - 0.08	0.05 - 0.1	0.06 - 0.11	0.07 - 0.13	0.08 - 0.15	0.08 - 0.15	0.3 x DC	0.2 x DC
H	Hardened steel SKD6, SKT4, etc. 55NiCrMoV7, etc.	40 - 50 HRC	40 - 80	0.03 - 0.07	0.03 - 0.07	0.04 - 0.08	0.05 - 0.1	0.06 - 0.11	0.07 - 0.13	0.08 - 0.15	0.08 - 0.15	0.3 x DC	0.2 x DC
	Hardened steel SKD11, SKH51, etc. HS6-5-2, etc.	50 - 60 HRC	20 - 60	0.03 - 0.07	0.03 - 0.07	0.04 - 0.08	0.05 - 0.1	0.06 - 0.11	0.07 - 0.13	0.08 - 0.15	0.08 - 0.15	0.3 x DC	0.2 x DC

Profiling for semi-finishing and finishing

VBB-BM / BG / SG, VBD-BG, VBE-BGA

ISO	Workpiece material	Hardness	Cutting speed V_c (m/min)	Feed per tooth: f_z (mm/t)								Depth of cut a_p (mm)	Pick feed P_f (mm)
				Tool diameter: DC (mm)									
				5	6	8	10	12	16	20	25		
P	Carbon steel S45C, S55C, etc. C45, C55, etc.	- 300 HB	120 - 250	0.04 - 0.09	0.04 - 0.09	0.06 - 0.11	0.07 - 0.12	0.08 - 0.13	0.09 - 0.16	0.1 - 0.18	0.1 - 0.18	0.1 x DC	0.15 x DC
	Alloy steel SCM440, SCr420, etc. 42CrMo4, 20Cr4, etc.	- 300 HB	100 - 220	0.04 - 0.09	0.04 - 0.09	0.06 - 0.11	0.07 - 0.12	0.08 - 0.13	0.09 - 0.16	0.1 - 0.18	0.1 - 0.18	0.1 x DC	0.15 x DC
	Prehardened steel PX5, NAK80, etc.	30 - 40 HRC	100 - 200	0.04 - 0.09	0.04 - 0.09	0.06 - 0.11	0.07 - 0.12	0.08 - 0.13	0.09 - 0.16	0.1 - 0.18	0.1 - 0.18	0.1 x DC	0.15 x DC
M	Stainless steel SUS304, SUS316, etc. X5CrNi18-9, X5CrNiMo17-12-2, etc.	- 200 HB	80 - 120	0.04 - 0.09	0.04 - 0.09	0.06 - 0.11	0.07 - 0.12	0.08 - 0.13	0.09 - 0.16	0.1 - 0.18	0.1 - 0.18	0.1 x DC	0.15 x DC
K	Grey cast iron FC250, FC300, etc. 250, 300, etc., GG250, GG300, etc.	150 - 250 HB	120 - 280	0.04 - 0.09	0.04 - 0.09	0.06 - 0.11	0.07 - 0.12	0.08 - 0.13	0.09 - 0.16	0.1 - 0.18	0.1 - 0.18	0.1 x DC	0.15 x DC
	Ductile cast iron FCD450, etc. 450-10S, etc., GGG450, etc.	150 - 250 HB	120 - 280	0.04 - 0.09	0.04 - 0.09	0.06 - 0.11	0.07 - 0.12	0.08 - 0.13	0.09 - 0.16	0.1 - 0.18	0.1 - 0.18	0.1 x DC	0.15 x DC
N	Aluminium alloys Si < 13%	-	300 - 1000	0.04 - 0.09	0.04 - 0.09	0.06 - 0.11	0.07 - 0.12	0.08 - 0.13	0.09 - 0.16	0.1 - 0.18	0.1 - 0.18	0.1 x DC	0.15 x DC
	Aluminium alloys Si ≥ 13%	-	150 - 400	0.04 - 0.09	0.04 - 0.09	0.06 - 0.11	0.07 - 0.12	0.08 - 0.13	0.09 - 0.16	0.1 - 0.18	0.1 - 0.18	0.1 x DC	0.15 x DC
S	Titanium alloys Ti-6Al-4V, etc.	-	50 - 100	0.04 - 0.09	0.04 - 0.09	0.06 - 0.11	0.07 - 0.12	0.08 - 0.13	0.09 - 0.16	0.1 - 0.18	0.1 - 0.18	0.08 x DC	0.1 x DC
	Heat-resistant alloys Inconel 718, etc.	-	30 - 50	0.04 - 0.09	0.04 - 0.09	0.06 - 0.11	0.07 - 0.12	0.08 - 0.13	0.09 - 0.16	0.1 - 0.18	0.1 - 0.18	0.08 x DC	0.1 x DC
H	Hardened steel SKD6, SKT4, etc. 55NiCrMoV7, etc.	40 - 50 HRC	50 - 100	0.04 - 0.09	0.04 - 0.09	0.06 - 0.11	0.07 - 0.12	0.08 - 0.13	0.09 - 0.16	0.1 - 0.18	0.1 - 0.18	0.08 x DC	0.1 x DC
	Hardened steel SKD11, SKH51, etc. HS6-5-2, etc.	50 - 60 HRC	30 - 80	0.04 - 0.09	0.04 - 0.09	0.06 - 0.11	0.07 - 0.12	0.08 - 0.13	0.09 - 0.16	0.1 - 0.18	0.1 - 0.18	0.08 x DC	0.1 x DC

HEADS

VRB**-02..., VRC**-02...

2 flute, roughing - semi finishing, economical

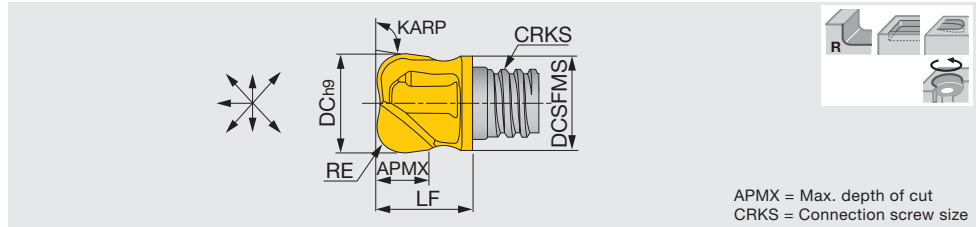

APMX = Max. depth of cut
CRKS = Connection screw size

Designation	AH725	NOF	FHA	DC	DCSFMS	APMX	RE	KARP	CRKS	LF	Wrench	Torque*
VRC100L07.0R05-02S06	●	2	15°	10	9.5	7	0.5	95°	S06	12.4	KEYV-S06	10
VRC100L07.0R10-02S06	●	2	15°	10	9.5	7	1	95°	S06	12.4	KEYV-S06	10
VRB100L06.0R20-02S06	●	2	0°	10	9.2	6	2	97°	S06	12.4	KEYV-S06	10
VRB120L05.7R30-02S06	●	2	0°	12	9.5	5.7	3	97°	S06	9.1	***KEYV-S08	10
VRB120L05.4R40-02S06	●	2	0°	12	9.5	5.4	4	97°	S06	9.1	***KEYV-S08	10
VRB120L06.3R16-02S08	●	2	0°	12	11.5	5.9	1.6	97°	S08	11.1	KEYV-S08	15
VRB120L06.2R20-02S08	●	2	0°	12	11.5	6.2	2	97°	S08	11.1	KEYV-S08	15
VRB120L06.1R25-02S08	●	2	0°	12	11.5	5.8	2.5	97°	S08	11.1	KEYV-S08	15
VRB120L06.1R30-02S08	●	2	0°	12	11.5	5.7	3	97°	S08	11.1	KEYV-S08	15
VRB120L05.9R40-02S08	●	2	0°	12	11.5	5.5	4	97°	S08	11.1	KEYV-S08	15
VRB160L08.0R50-02S10	●	2	0°	16	15.2	8	5	97°	S10	20.2	KEYV-S10	28
VRB200L11.1R30-02S12	●	2	0°	20	18.3	11	3	97°	S12	17	KEYV-S12	28
VRB200L11.5R40-02S12	●	2	0°	20	18.3	11.3	4	97°	S12	17.3	KEYV-S12	28
VRB200L11.5R50-02S12	●	2	0°	20	18.3	11.3	5	97°	S12	17.3	KEYV-S12	28
VRB200L11.4R60-02S12	●	2	0°	20	18.3	11.2	6	97°	S12	17.3	KEYV-S12	28
VRB200L11.3R80-02S12	●	2	0°	20	18.3	11.1	8	97°	S12	17.3	KEYV-S12	28

Suitable for contouring operation.

* Recommended clamping torque (N·m)

*** The wrench size for these heads is different from the ones for the other head types.

2 pieces per package

● : Line up

VRD**-06...

6 flute, semi finishing - finishing, helix cutting edge

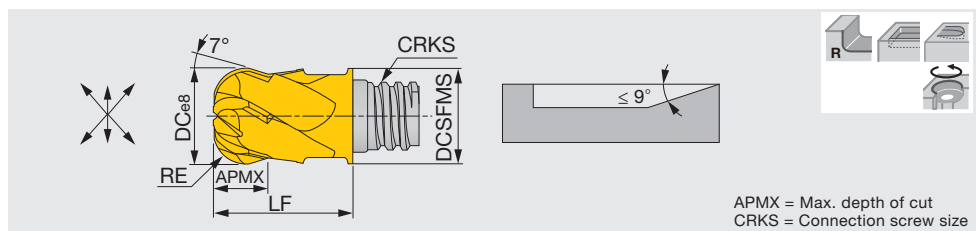

APMX = Max. depth of cut
CRKS = Connection screw size

Designation	AH725	NOF	FHA	DC	DCSFMS	APMX	RE	CRKS	LF	Wrench	Torque*
VRD080L04.0R20-06S05	●	6	30°	8	7.7	4	2	S05	10	KEYV-S05	7
VRD100L05.0R30-06S06	●	6	30°	10	9.7	5	3	S06	13	KEYV-S06	10
VRD120L07.0R40-06S08	●	6	30°	12	11.7	7	4	S08	16.5	KEYV-S08	15
VRD160L09.0R50-06S10	●	6	30°	16	15.3	9	5	S10	20.5	KEYV-S10	28

* Recommended clamping torque (N·m)

2 pieces per package

● : Line up

STANDARD CUTTING CONDITIONS

Shoulder milling

VRB, VRC, VRD

ISO	Workpiece material	Hardness	Cutting speed V_c (m/min)	Feed per tooth: f_z (mm/t)					Depth of cut a_p (mm)	Width of cut a_e (mm)
				Tool diameter: DC (mm)						
				8	10	12	16	20		
P	Carbon steel S45C, S55C, etc. C45, C55, etc.	- 300 HB	80 - 180	0.05 - 0.09	0.07 - 0.12	0.08 - 0.13	0.09 - 0.15	0.1 - 0.17	0.6 x DC	0.25 x DC
	Alloy steel SCM440, SCr420, etc. 42CrMo4, 20Cr4, etc.	- 300 HB	60 - 140	0.05 - 0.09	0.07 - 0.12	0.08 - 0.13	0.09 - 0.15	0.1 - 0.17	0.6 x DC	0.25 x DC
	Prehardened steel PX5, NAK80, etc.	30 - 40 HRC	60 - 120	0.05 - 0.09	0.07 - 0.12	0.08 - 0.13	0.09 - 0.15	0.1 - 0.17	0.6 x DC	0.25 x DC
M	Stainless steel SUS304, SUS316, etc. X5CrNi18-9, X5CrNiMo17-12-2, etc.	- 200 HB	40 - 100	0.05 - 0.09	0.07 - 0.12	0.08 - 0.13	0.09 - 0.15	0.1 - 0.17	0.6 x DC	0.25 x DC
K	Grey cast iron FC250, FC300, etc. 250, 300, etc., GG250, GG300, etc.	150 - 250 HB	80 - 200	0.05 - 0.09	0.07 - 0.12	0.08 - 0.13	0.09 - 0.15	0.1 - 0.17	0.6 x DC	0.25 x DC
	Ductile cast iron FCD450, etc. 450-10S, etc., GGG450, etc.	150 - 250 HB	80 - 200	0.05 - 0.09	0.07 - 0.12	0.08 - 0.13	0.09 - 0.15	0.1 - 0.17	0.6 x DC	0.25 x DC
N	Aluminium alloys Si < 13%	-	200 - 700	0.05 - 0.09	0.07 - 0.12	0.08 - 0.13	0.09 - 0.15	0.1 - 0.17	0.6 x DC	0.25 x DC
	Aluminium alloys Si ≥ 13%	-	100 - 300	0.05 - 0.09	0.07 - 0.12	0.08 - 0.13	0.09 - 0.15	0.1 - 0.17	0.6 x DC	0.25 x DC
S	Titanium alloys Ti-6Al-4V, etc.	-	40 - 80	0.05 - 0.09	0.07 - 0.12	0.08 - 0.13	0.09 - 0.15	0.1 - 0.17	0.6 x DC	0.25 x DC
	Heat-resistant alloys Inconel 718, etc.	-	20 - 40	0.05 - 0.09	0.07 - 0.12	0.08 - 0.13	0.09 - 0.15	0.1 - 0.17	0.6 x DC	0.25 x DC
H	Hardened steel SKD6, SKT4, etc. 55NiCrMoV7, etc.	40 - 50 HRC	40 - 80	0.05 - 0.09	0.07 - 0.12	0.08 - 0.13	0.09 - 0.15	0.1 - 0.17	0.6 x DC	0.25 x DC
	Hardened steel SKD11, SKH51, etc. HS6-5-2, etc.	50 - 60 HRC	20 - 60	0.05 - 0.09	0.07 - 0.12	0.08 - 0.13	0.09 - 0.15	0.1 - 0.17	0.6 x DC	0.25 x DC

Slotting

VRB, VRC, VRD

ISO	Workpiece material	Hardness	Cutting speed V_c (m/min)	Feed per tooth: f_z (mm/t)					Depth of cut a_p (mm)
				Tool diameter: DC (mm)					
				8	10	12	16	20	
P	Carbon steel S45C, S55C, etc. C45, C55, etc.	- 300 HB	50 - 70	0.03 - 0.04	0.04 - 0.05	0.05 - 0.06	0.06 - 0.08	0.07 - 0.1	0.5 x DC
	Alloy steel SCM440, SCr420, etc. 42CrMo4, 20Cr4, etc.	- 300 HB	40 - 80	0.03 - 0.04	0.04 - 0.05	0.05 - 0.06	0.06 - 0.08	0.07 - 0.1	0.5 x DC
	Prehardened steel PX5, NAK80, etc.	30 - 40 HRC	40 - 70	0.03 - 0.04	0.04 - 0.05	0.05 - 0.06	0.06 - 0.08	0.07 - 0.1	0.5 x DC
M	Stainless steel SUS304, SUS316, etc. X5CrNi18-9, X5CrNiMo17-12-2, etc.	- 200 HB	30 - 60	0.03 - 0.04	0.04 - 0.05	0.05 - 0.06	0.06 - 0.08	0.07 - 0.1	0.5 x DC
K	Grey cast iron FC250, FC300, etc. 250, 300, etc., GG250, GG300, etc.	150 - 250 HB	50 - 120	0.03 - 0.04	0.04 - 0.05	0.05 - 0.06	0.06 - 0.08	0.07 - 0.1	0.5 x DC
	Ductile cast iron FCD450, etc. 450-10S, etc., GGG450, etc.	150 - 250 HB	50 - 120	0.03 - 0.04	0.04 - 0.05	0.05 - 0.06	0.06 - 0.08	0.07 - 0.1	0.5 x DC
N	Aluminium alloys Si < 13%	-	130 - 400	0.03 - 0.04	0.04 - 0.05	0.05 - 0.06	0.06 - 0.08	0.07 - 0.1	0.5 x DC
	Aluminium alloys Si ≥ 13%	-	70 - 200	0.03 - 0.04	0.04 - 0.05	0.05 - 0.06	0.06 - 0.08	0.07 - 0.1	0.5 x DC
S	Titanium alloys Ti-6Al-4V, etc.	-	20 - 40	0.03 - 0.04	0.04 - 0.05	0.05 - 0.06	0.06 - 0.08	0.07 - 0.1	0.5 x DC
	Heat-resistant alloys Inconel 718, etc.	-	10 - 20	0.03 - 0.04	0.04 - 0.05	0.05 - 0.06	0.06 - 0.08	0.07 - 0.1	0.5 x DC
H	Hardened steel SKD6, SKT4, etc. 55NiCrMoV7, etc.	40 - 50 HRC	25 - 60	0.03 - 0.04	0.04 - 0.05	0.05 - 0.06	0.06 - 0.08	0.07 - 0.1	0.5 x DC
	Hardened steel SKD11, SKH51, etc. HS6-5-2, etc.	50 - 60 HRC	10 - 30	0.03 - 0.04	0.04 - 0.05	0.05 - 0.06	0.06 - 0.08	0.07 - 0.1	0.5 x DC

HEADS

VBO...

4, 5 flute, semi finishing - finishing, long edge, high productive profiling

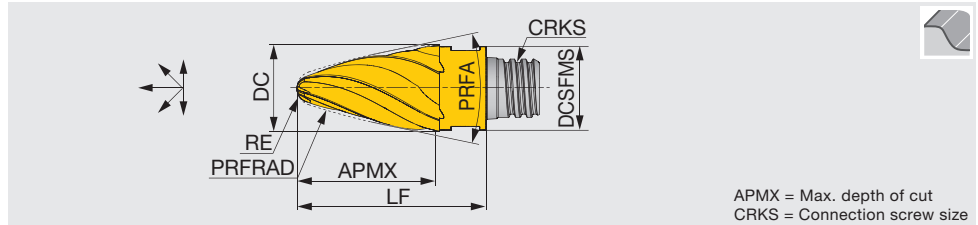

APMX = Max. depth of cut
CRKS = Connection screw size

Designation	AH715	NOF	FHA	DC	DCSFMS	APMX	RE	PRFRAD	PRFA	CRKS	LF	Wrench	Torque*
VBO080L12.0R900-4S05	●	4	30°	8	7.7	12	1	90	33.6°	S05	18	KEYV-S05	7
VBO100L15.0R850-5S06	●	5	30°	10	9.7	15	2	85	27.3°	S06	22	KEYV-S06	10
VBO120L19.0R800-5S08	●	5	30°	12	11.7	19	2	80	29.3°	S08	27	KEYV-S08	15
VBO160L25.0R750-5S10	●	5	30°	16	15.3	25	3	75	26.7°	S10	33.5	KEYV-S10	28

* Recommended clamping torque (N-m)
2 pieces per package

● : New product
● : Line up

VBO...

4 flute, semi finishing - finishing, short edge, high productive profiling

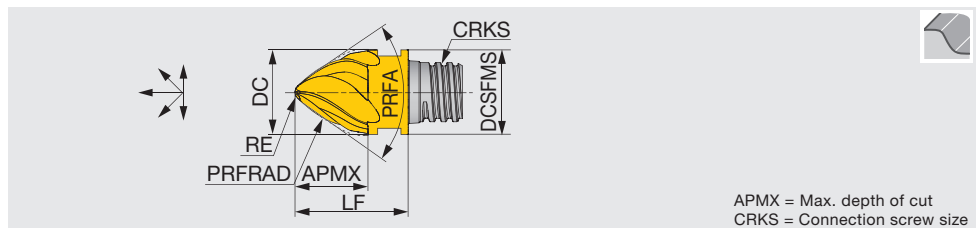

APMX = Max. depth of cut
CRKS = Connection screw size

Designation	AH715	NOF	FHA	DC	DCSFMS	APMX	RE	PRFRAD	PRFA	CRKS	LF	Wrench	Torque*
VBO100L08.0R250-4S06	●	4	30°	10	9.7	8	0.8	25	70.8°	S06	13	KEYV-S06	10
VBO120L09.0R300-4S08	●	4	30°	12	11.7	9	1.2	30	71.6°	S08	16.5	KEYV-S08	15
VBO160L13.0R400-4S10	●	4	30°	16	15.3	13	1.6	40	70.3°	S10	20.5	KEYV-S10	28

* Recommended clamping torque (N-m)
2 pieces per package

● : Line up

VBN...

6 flute, semi finishing - finishing, high productive profiling

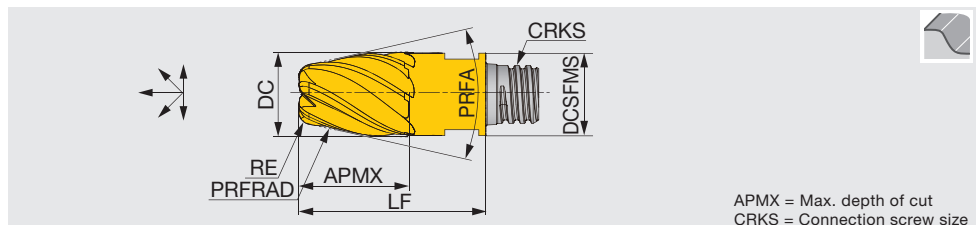

APMX = Max. depth of cut
CRKS = Connection screw size

Designation	AH715	NOF	FHA	DC	DCSFMS	APMX	RE	PRFRAD	PRFA	CRKS	LF	Wrench	Torque*
VBN100L13.0R450-6S06	●	6	35°	10	9.7	13	1.5	45	15.1°	S06	22	KEYV-S06	10
VBN120L15.0R500-6S08	●	6	35°	12	11.7	15	2	50	15.1°	S08	27	KEYV-S08	15
VBN160L18.0R600-6S10	●	6	35°	16	15.3	18	2	60	15.1°	S10	33.5	KEYV-S10	28

* Recommended clamping torque (N-m)
2 pieces per package

● : Line up

VBL...

6 flute, semi finishing - finishing, high productive profiling

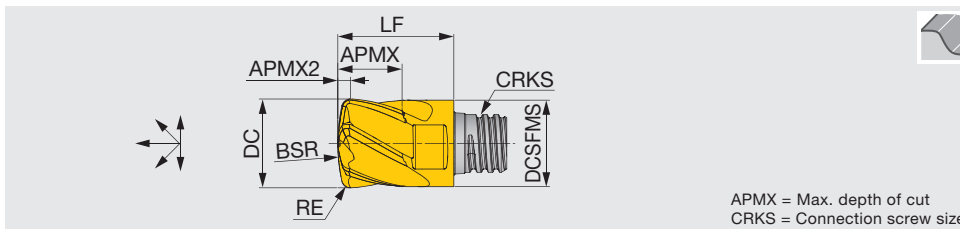

APMX = Max. depth of cut
CRKS = Connection screw size

Designation	AH715	NOF	FHA	DC	DCSFMS	APMX	APMX2	RE	BSR	CRKS	LF	Wrench	Torque*
VBL080L0.90R160-6S05	●	6	30°	8	7.7	5.5	0.9	0.5	16	S05	10	KEYV-S05	7
VBL100L1.40R200-6S06	●	6	30°	10	9.7	7.5	1.42	1	20	S06	13	KEYV-S06	10
VBL120L1.50R240-6S08	●	6	30°	12	11.7	9	1.55	1	24	S08	16.5	KEYV-S08	15
VBL160L1.80R320-6S10	●	6	30°	16	15.3	12	1.8	1	32	S10	20.5	KEYV-S10	28

* Recommended clamping torque (N·m)
2 pieces per package

● : New product

TARGET APPLICATIONS

VBO-short

Convex-curved surfaces, tapered surfaces, and surfaces consisting of combinations of a small corner radius and walls (the corner radius must be larger than the tool's nose radius).



VBO-long

Convex-curved and tapered surfaces in gentler profile than those of VBO-short.



VBN

Impellers, blisks, blades, and other aerospace parts.



STANDARD CUTTING CONDITIONS

Profiling

VBO, VBN, VBL

ISO	Workpiece material	Hardness	Cutting speed V _c (m/min)	Feed per tooth: fz (mm/t)			Cusp height (mm)
				Tool diameter: DC (mm)			
				10	12	16	
P	Low carbon steel S45C, S55C, etc. C45, C55, etc.	- 300 HB	100 - 200	0.05 - 0.1	0.06 - 0.11	0.07 - 0.13	0.1
	High carbon steel SCM440, SCr415, etc. 42CrMo4, 15Cr3, etc.	- 300 HB	80 - 180	0.05 - 0.1	0.06 - 0.11	0.07 - 0.13	0.1
	Prehardened steel PX5, NAK80, etc.	30 - 40 HRC	80 - 160	0.05 - 0.1	0.06 - 0.11	0.07 - 0.13	0.1
M	Stainless steel SUS304, SUS316, etc. X5CrNi18-9, X5CrNiMo17-12-2, etc.	- 200 HB	60 - 100	0.05 - 0.1	0.06 - 0.11	0.07 - 0.13	0.1
K	Grey cast iron FC250, FC300, etc. 250, 300, etc.	150 - 250 HB	100 - 220	0.05 - 0.1	0.06 - 0.11	0.07 - 0.13	0.1
	Ductile cast iron FCD400, etc. 400-15S, etc.	150 - 250 HB	100 - 220	0.05 - 0.1	0.06 - 0.11	0.07 - 0.13	0.1
N	Aluminium alloys Si < 13%	-	200 - 700	0.05 - 0.1	0.06 - 0.11	0.07 - 0.13	0.1
	Aluminium alloys Si ≥ 13%	-	100 - 300	0.05 - 0.1	0.06 - 0.11	0.07 - 0.13	0.1
S	Titanium alloys Ti-6Al-4V, etc.	-	40 - 80	0.05 - 0.1	0.06 - 0.11	0.07 - 0.13	0.1
	Heat-resistant alloys Inconel718, etc.	50 - 60 HRC	20 - 40	0.05 - 0.1	0.06 - 0.11	0.07 - 0.13	0.1
H	Hardened steel SKD61, SKT4, etc. X40CrMoV5-1, 55NiCrMoV6, etc.	-	40 - 80	0.05 - 0.1	0.06 - 0.11	0.07 - 0.13	0.1
	Hardened steel SKD11, SKH, etc. X153CrMoV12, HS18-0-1, etc.	50 - 60 HRC	20 - 60	0.05 - 0.1	0.06 - 0.11	0.07 - 0.13	0.1

TIPS FOR USING ON 3-AXIS MACHINES

The **VBO/VBN** milling heads are designed for the use on 5-axis machines. However, they are also effective on 3-axis machining centers when either of the following conditions is satisfied.

1. The angled walls or curved surfaces to be machined have tilt angles within the range specified in the chart on the right.
2. Use as a regular tapered ball mill with only the nose radius of the tool tip, and not the radius on the tool side, to be used. Please note that the working diameter will be smaller than those of a ball mill of the same working diameter.

	Designation	Applicable ranges of tilt angles on workpiece		
		Min.	Mean	Max.
VBO-short	VBO100L08.0R250-4S06	56°	70.8°	85°
	VBO120L09.0R300-4S08	58°	71.6°	85°
	VBO160L13.0R400-4S10	56°	70.3°	85°
VBO-long	VBO100L15.0R850-5S06	20°	27.3°	35°
	VBO120L19.0R800-5S08	19°	29.3°	40°
	VBO160L25.0R750-5S10	10°	26.7°	43°
VBN	VBN100L13.0R450-6S06	0°	15.1°	29°
	VBN120L15.0R500-6S08	0°	15.1°	29°
	VBN160L18.0R600-6S10	0°	15.1°	29°

HEADS

VCA**-04/06...

4, 6 flute, chamfering angle: 45°

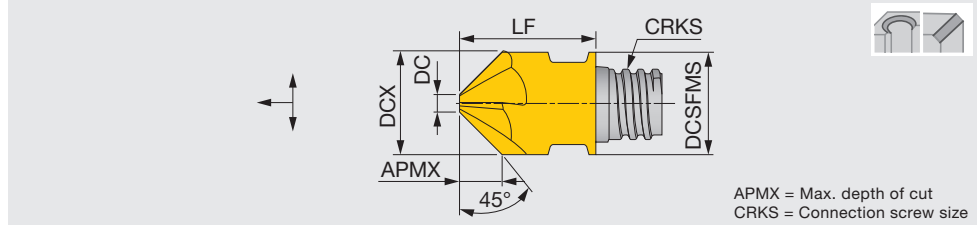

APMX = Max. depth of cut
CRKS = Connection screw size

Designation	AH715	AH725	NOF	FHA	DCX	DCSFMS	APMX	DC	CRKS	LF	Wrench	Torque*
VCA100L04.0A45-04S06	●	●	4	0°	10	10	4	1.95	S06	13	KEYV-S06	10
VCA120L05.0A45-04S08	●	●	4	0°	12	12	5	1.95	S08	16.5	KEYV-S08	15
VCA127L05.3A45-04S08	●	●	4	0°	12.7	12.7	5.3	1.98	S08	16.5	KEYV-S08	15
VCA160L06.5A45-06S10	●	●	6	0°	16	16	6.5	3	S10	20.3	KEYV-S10	28
VCA200L07.5A45-06S12	●	●	6	0°	20	18.3	7.5	5	S12	25.5	KEYV-S12	28

* Recommended clamping torque (N·m)
2 pieces per package

● : New product
● : Line up

VCW**-02...

2 flute, chamfering angle: 45°, back chamfering capability

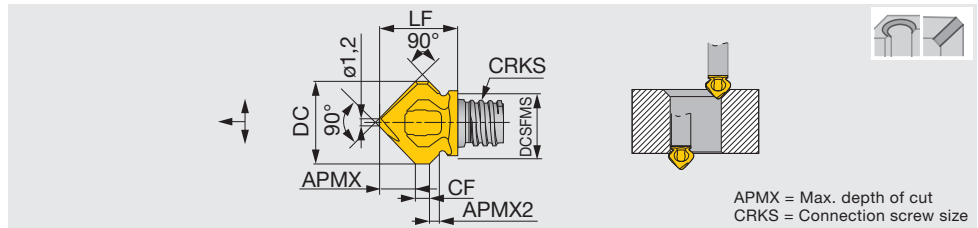

APMX = Max. depth of cut
CRKS = Connection screw size

Designation	AH715	AH725	NOF	FHA	DC	DCSFMS	APMX	APMX2	CF	CRKS	LF	Wrench	Torque*
VCW118L05.0A45-02S06	●	●	2	0°	11.8	9.3	5	1.2	2	S06	11.2	***KEYV-S08	10

Available for chamfering of reverse side.

* Recommended clamping torque (N·m)

*** The wrench size for these heads is different from the ones for the other head types.

2 pieces per package

● : Line up

VCR**-02...

2 flute, radius chamfering

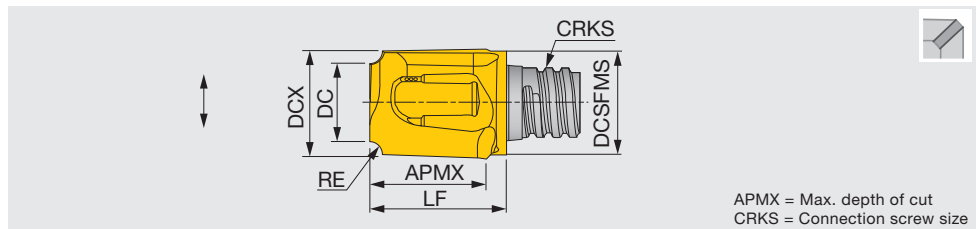

APMX = Max. depth of cut
CRKS = Connection screw size

Designation	AH725	NOF	FHA	DCX	DCSFMS	DC	APMX	RE	CRKS	LF	Wrench	Torque*
VCR080L07.5R10-02S05	●	2	0°	8	7.6	5.8	7.5	1	S05	10.5	KEYV-S05	7
VCR100L09.5R16-02S06	●	2	0°	10	9.5	6.8	9.5	1.6	S06	12.5	KEYV-S06	10
VCR100L09.5R25-02S06	●	2	0°	10	9.5	5.1	9.5	2.5	S06	12.5	KEYV-S06	10
VCR127L12.0R30-02S08	●	2	0°	12.7	12.2	6.5	12	3	S08	15.6	KEYV-S08	15
VCR127L12.0R40-02S08	●	2	0°	12.7	12.2	4.7	12	4	S08	15.6	KEYV-S08	15
VCR160L15.0R50-02S10	●	2	0°	16	15.2	6.2	15	5	S10	19.1	KEYV-S10	28
VCR200L07.0R60-02S12	●	2	0°	20	18.3	8	7	6	S12	17.4	KEYV-S12	28

* Recommended clamping torque (N·m)
2 pieces per package

● : Line up

STANDARD CUTTING CONDITIONS

Chamfering and countersinking (Milling, Z-feed chamfering)

VCA, VCW, VCR

ISO	Workpiece material	Hardness	Cutting speed Vc (m/min)	Feed per tooth fz (mm/t)
P	Carbon steel S45C, S55C, etc. C45, C55, etc.	- 300 HB	60 - 100	0.03 - 0.06
	Alloy steel SCM440, SCr420, etc. 42CrMo4, 20Cr4, etc.	- 300 HB	50 - 80	0.03 - 0.06
	Prehardened steel PX5, NAK80, etc.	30 - 40 HRC	40 - 70	0.03 - 0.06
M	Stainless steel SUS304, SUS316, etc. X5CrNi18-9, X5CrNiMo17-12-2, etc.	- 200 HB	30 - 50	0.03 - 0.06
K	Grey cast iron FC250, FC300, etc. 250, 300, etc., GG250, GG300, etc.	150 - 250 HB	80 - 120	0.03 - 0.06
	Ductile cast iron FCD450, etc. 450-10S, etc., GGG450, etc.	150 - 250 HB	80 - 120	0.03 - 0.06
N	Aluminium alloys	-	100 - 200	0.04 - 0.08
S	Titanium alloys Ti-6Al-4V, etc.	-	30 - 50	0.025 - 0.05
	Heat-resistant alloys Inconel 718, etc.	-	20 - 40	0.02 - 0.04
H	Hardened steel SKD6, SKT4, etc. 55NiCrMoV7, etc.	40 - 50 HRC	30 - 50	0.025 - 0.05
	Hardened steel SKD11, SKH51, etc. HS6-5-2, etc.	50 - 60 HRC	20 - 40	0.02 - 0.04

HEADS

VCP**-02...

2 flute, chamfering angle: 30°, 45°, 60°

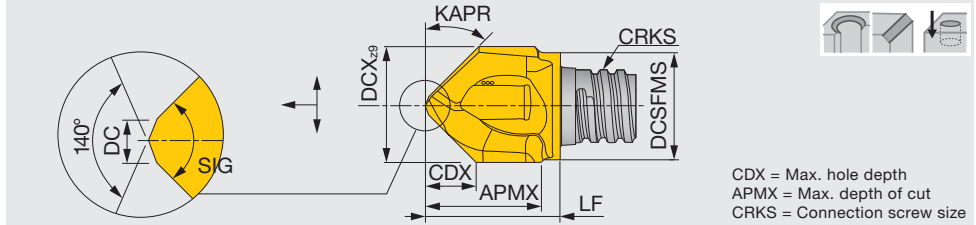

Designation	AH715	AH725	SIG	NOF	FHA	DCX	DCSFMS	APMX	CDX	CRKS	LF	DC	KAPR	Wrench	Torque*
VCP100L09.5A30-02S06	●		60°	2	0°	10	9.5	8.5	7.5	S06	11.75	1.5	60°	KEYV-S06	10
VCP120L12.0A30-02S08	●		60°	2	0°	12	11.5	11	9.2	S08	15.4	1.5	60°	KEYV-S08	15
VCP160L15.0A30-02S10	●		60°	2	0°	16	15.2	16	12	S10	20.2	2.5	60°	KEYV-S10	28
VCP080L07.7A45-02S05	●	●	90°	2	0°	8	7.6	7.5	3.7	S05	9.75	1	45°	KEYV-S05	7
VCP083L07.9A45-02S05	●		90°	2	0°	8.3	7.6	7.5	3.8	S05	10	1	45°	KEYV-S05	7
VCP100L09.0A45-02S06	●	●	90°	2	0°	10	9.5	9.5	4.4	S06	11.75	1.5	45°	KEYV-S06	10
VCP104L09.0A45-02S06	●		90°	2	0°	10.4	9.5	9.5	4.6	S06	11.75	1.5	45°	KEYV-S06	10
VCP120L12.0A45-02S08	●		90°	2	0°	12	11.5	11.5	5.4	S08	15.4	1.5	45°	KEYV-S08	15
VCP124L12.0A45-02S08	●		90°	2	0°	12.4	11.5	11.5	5.6	S08	15.4	1.5	45°	KEYV-S08	15
VCP160L15.0A45-02S10	●	●	90°	2	0°	16	15.2	15	7.1	S10	18.8	1.5	45°	KEYV-S10	28
VCP165L15.0A45-02S10	●		90°	2	0°	16.5	15.2	15	7.1	S10	18.8	1.5	45°	KEYV-S10	28
VCP100L09.5A60-02S06	●	●	120°	2	0°	10	9.5	9.5	2.7	S06	12.7	1.5	30°	KEYV-S06	10
VCP120L12.0A60-02S08	●		120°	2	0°	12	11.5	11.5	3.3	S08	15.2	1.5	30°	KEYV-S08	15
VCP160L15.5A60-02S10	●		120°	2	0°	16	15.2	16	4.4	S10	19.9	1.5	30°	KEYV-S10	28

* Recommended clamping torque (N·m)
2 pieces per package

● : Line up

VDS...

2 flute, chamfering angle: 45°, helix cutting edge

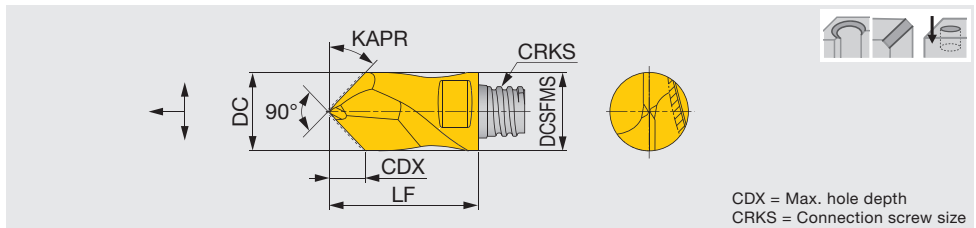

Designation	AH725	NOF	FHA	DC	DCSFMS	CDX	KAPR	CRKS	LF	Wrench	Torque*
VDS080A45-02S05	●	2	10°	8	7.7	3.7	45°	S05	15	KEYV-S05	7
VDS100A45-02S06	●	2	10°	10	9.7	4.4	45°	S06	19	KEYV-S06	10
VDS120A45-02S08	●	2	10°	12	11.7	5.4	45°	S08	23	KEYV-S08	15
VDS160A45-02S10	●	2	10°	16	15.3	7.1	45°	S10	28	KEYV-S10	28

* Recommended clamping torque (N·m)
2 pieces per package

● : New product

STANDARD CUTTING CONDITIONS

Spot drill

VCP, VDS

ISO	Workpiece material	Hardness	Cutting speed Vc (m/min)	Feed f (mm/rev)
P	Carbon steel S45C, S55C, etc. C45, C55, etc.	- 300 HB	60 - 100	0.06 - 0.12
	Alloy steel SCM440, SCr420, etc. 42CrMo4, 20Cr4, etc.	- 300 HB	50 - 80	0.06 - 0.12
	Prehardened steel PX5, NAK80, etc.	30 - 40 HRC	40 - 70	0.06 - 0.12
M	Stainless steel SUS304, SUS316, etc. X5CrNi18-9, X5CrNiMo17-12-2, etc.	- 200 HB	30 - 50	0.06 - 0.12
K	Grey cast iron FC250, FC300, etc. 250, 300, etc., GG250, GG300, etc.	150 - 250 HB	80 - 120	0.06 - 0.12
	Ductile cast iron FCD450, etc. 450-10S, etc., GGG450, etc.	150 - 250 HB	80 - 120	0.06 - 0.12
N	Aluminium alloys	-	100 - 200	0.08 - 0.16
S	Titanium alloys Ti-6Al-4V, etc.	-	30 - 50	0.05 - 0.1
	Heat-resistant alloys Inconel 718, etc.	-	20 - 40	0.04 - 0.08
H	Hardened steel SKD6, SKT4, etc. 55NiCrMoV7, etc.	40 - 50 HRC	30 - 50	0.05 - 0.1
	Hardened steel SKD11, SKH51, etc. HS6-5-2, etc.	50 - 60 HRC	20 - 40	0.04 - 0.08

HEADS

VDP**-02...

2 flute, A/B type center

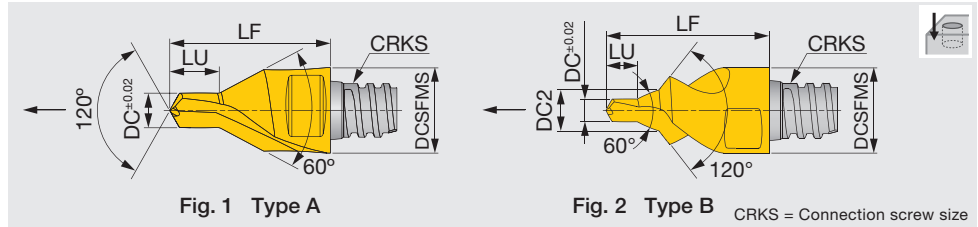

Designation	AH725	NOF	FHA	DC±0.02	DC2	DCSFMS	LU	CRKS	LF	Wrench	Torque*	Fig.
VDP107L1.60A30-02S04	●	2	0°	1.07	-	6	1.6	S04	10	KEYV-S05	4	1
VDP165L2.40A30-02S04	●	2	0°	1.65	-	6	2.4	S04	10	KEYV-S05	4	1
VDP207L2.90A30-02S04	●	2	0°	2.07	-	6	2.9	S04	10	KEYV-S05	4	1
VDP328L04.6A30-02S05	●	2	0°	3.28	-	8	4.6	S05	15	KEYV-S05	7	1
VDP412L05.9A30-02S06	●	2	0°	4.12	-	10	5.9	S06	19	KEYV-S06	10	1
VDP513L07.2A30-02S08	●	2	0°	5.13	-	12	7.2	S08	23	KEYV-S08	15	1
VDP646L08.9A30-02S10	●	2	0°	6.46	-	16	8.9	S10	28	KEYV-S10	28	1
VDP324L4.38B30-02S08	●	2	0°	3.24	6.77	12	4.4	S08	23	KEYV-S08	15	2
VDP409L5.60B30-02S08	●	2	0°	4.09	8.56	12.7	5.6	S08	23	KEYV-S08	15	2
VDP509L6.89B30-02S12	●	2	0°	5.09	10.69	18.45	6.9	S12	25.5	KEYV-S12	28	2
VDP641L8.63B30-02S12	●	2	0°	6.41	13.29	20	8.6	S12	25.5	KEYV-S12	28	2

* Recommended clamping torque (N·m)
2 pieces per package

● : New product
● : Line up

STANDARD CUTTING CONDITIONS

Center drill

VDP

ISO	Workpiece material	Hardness	Cutting speed Vc (m/min)	Feed : f (mm/rev)						
				VDP107	VDP165	VDP2	VDP3	VDP4	VDP5	VDP6
P	Carbon steel S45C, S55C, etc. C45, C55, etc.	- 300 HB	40 - 80	0.02 - 0.04	0.025 - 0.05	0.025 - 0.05	0.04 - 0.08	0.05 - 0.1	0.05 - 0.1	0.06 - 0.12
	Alloy steel SCM440, SCr420, etc. 42CrMo4, 20Cr4, etc.	- 300 HB	30 - 50	0.02 - 0.04	0.025 - 0.05	0.025 - 0.05	0.04 - 0.08	0.05 - 0.1	0.05 - 0.1	0.06 - 0.12
	Prehardened steel PX5, NAK80, etc.	30 - 40 HRC	20 - 30	0.02 - 0.04	0.025 - 0.05	0.025 - 0.05	0.04 - 0.08	0.05 - 0.1	0.05 - 0.1	0.06 - 0.12
M	Stainless steel SUS304, SUS316, etc. X5CrNi18-9, X5CrNiMo17-12-2, etc.	- 200 HB	15 - 25	0.015 - 0.03	0.02 - 0.04	0.02 - 0.04	0.04 - 0.08	0.05 - 0.1	0.05 - 0.1	0.06 - 0.12
K	Grey cast iron FC250, FC300, etc. 250, 300, etc., GG250, GG300, etc.	150 - 250 HB	60 - 100	0.02 - 0.04	0.025 - 0.05	0.025 - 0.05	0.05 - 0.09	0.07 - 0.12	0.07 - 0.12	0.12 - 0.18
	Ductile cast iron FCD450, etc. 450-10S, etc., GGG450, etc.	150 - 250 HB	60 - 100	0.02 - 0.04	0.025 - 0.05	0.025 - 0.05	0.04 - 0.08	0.05 - 0.1	0.05 - 0.1	0.1 - 0.15
S	Titanium alloys Ti-6Al-4V, etc.	-	15 - 25	0.01 - 0.02	0.01 - 0.02	0.015 - 0.03	0.04 - 0.07	0.04 - 0.07	0.04 - 0.07	0.04 - 0.07
	Heat-resistant alloys Inconel 718, etc.	-	10 - 20	0.01 - 0.02	0.01 - 0.02	0.015 - 0.03	0.03 - 0.06	0.03 - 0.06	0.03 - 0.06	0.03 - 0.06
H	Hardened steel SKD6, SKT4, etc. 55NiCrMoV7, etc.	40 - 50 HRC	15 - 25	-	-	-	0.04 - 0.07	0.04 - 0.07	0.04 - 0.07	0.04 - 0.07
	Hardened steel SKD11, SKH51, etc. HS6-5-2, etc.	50 - 60 HRC	10 - 20	-	-	-	0.03 - 0.06	0.03 - 0.06	0.03 - 0.06	0.03 - 0.06

HEADS

VGC**-02...

2 flute, for counterboring (can be used for milling)

Counterboring

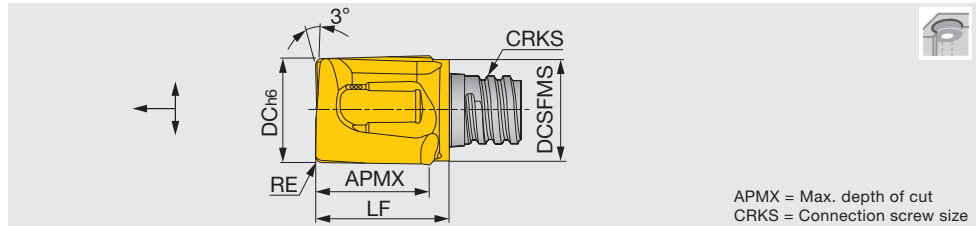

APMX = Max. depth of cut
CRKS = Connection screw size

Designation	AH725	NOF	FHA	DC	DCSFMS	APMX	RE	CRKS	LF	Wrench	Torque*
VGC078L08.0R02-02S05	●	2	10°	7.8	7.6	8	0.2	S05	10	KEYV-S05	7
VGC080L08.0R04-02S05	●	2	10°	8	7.6	8	0.4	S05	10	KEYV-S05	7
VGC080L08.0R10-02S05	●	2	10°	8	7.6	8	1	S05	10	KEYV-S05	7
VGC080L08.0R20-02S05	●	2	10°	8	7.6	8	2	S05	10	KEYV-S05	7
VGC098L09.0R03-02S06	●	2	10°	9.8	9.5	9.5	0.3	S06	12.4	KEYV-S06	10
VGC100L09.0R04-02S06	●	2	10°	10	9.5	9.5	0.4	S06	12.4	KEYV-S06	10
VGC100L09.0R10-02S06	●	2	10°	10	9.5	9.5	1	S06	12.4	KEYV-S06	10
VGC100L09.0R20-02S06	●	2	10°	10	9.5	9.5	2	S06	12.4	KEYV-S06	10
VGC117L10.0R03-02S08	●	2	10°	11.7	11.5	10	0.3	S08	14.2	KEYV-S08	15
VGC120L10.0R04-02S08	●	2	10°	12	11.5	10	0.4	S08	14.2	KEYV-S08	15
VGC120L10.0R10-02S08	●	2	10°	12	11.5	10	1	S08	14.2	KEYV-S08	15
VGC120L10.0R20-02S08	●	2	10°	12	11.5	10	2	S08	14.2	KEYV-S08	15
VGC157L15.0R03-02S10	●	2	10°	15.7	15.2	15	0.3	S10	19	KEYV-S10	28
VGC160L15.0R04-02S10	●	2	10°	16	15.2	15	0.4	S10	19	KEYV-S10	28
VGC160L15.0R08-02S10	●	2	10°	16	15.2	15	0.8	S10	19	KEYV-S10	28

Can drill with step feed

* Recommended clamping torque (N·m)

2 pieces per package

● : Line up

STANDARD CUTTING CONDITIONS

Counterboring

VGC

ISO	Workpiece material	Hardness	Cutting speed Vc (m/min)	Feed per tooth fz (mm/t)
	Carbon steel S45C, S55C, etc. C45, C55, etc.	- 300 HB	40 - 80	0.04 - 0.08
P	Alloy steel SCM440, SCr420, etc. 42CrMo4, 20Cr4, etc.	- 300 HB	30 - 50	0.04 - 0.08
	Prehardened steel PX5, NAK80, etc.	30 - 40 HRC	20 - 30	0.04 - 0.08
M	Stainless steel SUS304, SUS316, etc. X5CrNi18-9, X5CrNiMo17-12-2, etc.	- 200 HB	15 - 25	0.04 - 0.08
	Grey cast iron FC250, FC300, etc. 250, 300, etc., GG250, GG300, etc.	150 - 250 HB	60 - 100	0.05 - 0.09
K	Ductile cast iron FCD450, etc. 450-10S, etc., GGG450, etc.	150 - 250 HB	60 - 100	0.04 - 0.08
	Titanium alloys Ti-6Al-4V, etc.	-	15 - 25	0.04 - 0.07
S	Heat-resistant alloys Inconel 718, etc.	-	10 - 20	0.03 - 0.06
	Hardened steel SKD6, SKT4, etc. 55NiCrMoV7, etc.	40 - 50 HRC	15 - 25	0.04 - 0.07
H	Hardened steel SKD11, SKH51, etc. HS6-5-2, etc.	50 - 60 HRC	10 - 20	0.03 - 0.06

When drilling, pecking operation should be applied with the depth of 0.3 - 0.5 mm per step.

Apply the same cutting conditions as the VEE type head when conducting shoulder milling or slotting operations.

HEADS

VST**-3...

3 flute, for slotting

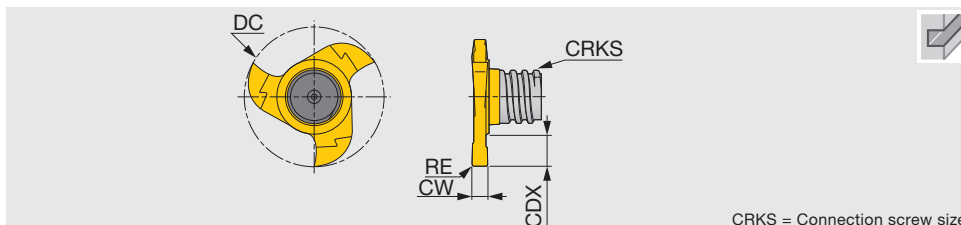
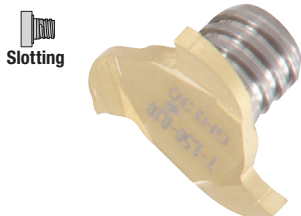

Designation	AH735	GH130	NOF	FHA	DC	CW±0.02	RE	CRKS	CDX	Wrench	Torque*
VST157W1.50R010-3S06		●	3	0°	15.7	1.5	0.1	S06	2.8	KEYV-177	10
VST157W1.57R020-3S06		●	3	0°	15.7	1.57	0.2	S06	2.8	KEYV-177	10
VST157W2.00R020-3S06		●	3	0°	15.7	2	0.2	S06	2.8	KEYV-177	10
VST157W2.39R020-3S06		●	3	0°	15.7	2.39	0.2	S06	2.8	KEYV-177	10
VST157W2.50R020-3S06		●	3	0°	15.7	2.5	0.2	S06	2.8	KEYV-177	10
VST157W3.00R020-3S06		●	3	0°	15.7	3	0.2	S06	2.8	KEYV-177	10
VST157W3.17R020-3S06		●	3	0°	15.7	3.17	0.2	S06	2.8	KEYV-177	10
VST177W1.20R005-3S06		●	3	0°	17.7	1.2 ⁽¹⁾	0.05	S06	3.8	KEYV-177	10
VST177W1.40R005-3S06		●	3	0°	17.7	1.4 ⁽¹⁾	0.05	S06	3.8	KEYV-177	10
VST177W1.50R010-3S06		●	3	0°	17.7	1.5	0.1	S06	3.8	KEYV-177	10
VST177W1.57R020-3S06		●	3	0°	17.7	1.57	0.2	S06	3.8	KEYV-177	10
VST177W1.70R005-3S06		●	3	0°	17.7	1.7 ⁽¹⁾	0.05	S06	3.8	KEYV-177	10
VST177W2.00R020-3S06		●	3	0°	17.7	2	0.2	S06	3.8	KEYV-177	10
VST177W2.20R110-3S06		●	3	0°	17.7	2.20	1.1	S06	3.8	KEYV-177	10
VST177W2.39R020-3S06		●	3	0°	17.7	2.39	0.2	S06	3.8	KEYV-177	10
VST177W2.50R020-3S06		●	3	0°	17.7	2.5	0.2	S06	3.8	KEYV-177	10
VST177W3.00R020-3S06	●	●	3	0°	17.7	3	0.2	S06	3.8	KEYV-177	10
VST177W3.17R020-3S06		●	3	0°	17.7	3.17	0.2	S06	3.8	KEYV-177	10

(1) CW is based on DIN471 / 472
 * Recommended clamping torque (N·m)
 2 pieces per package

● : Line up

VST**-4/6...

4, 6 flute, for slotting

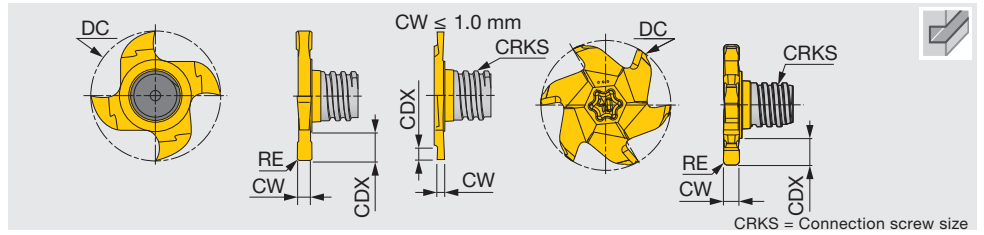
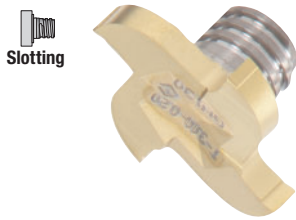

Designation	AH735	GH130	FHA	NOF	DC	CW±0.02	RE	CRKS	CDX	Wrench	Torque*
VST217W0.76R000-4S08		●	0°	4	21.7	0.76 ⁽¹⁾	-	S08	1.5	KEYV-217	15
VST217W0.86R000-4S08		●	0°	4	21.7	0.86 ⁽¹⁾	-	S08	1.7	KEYV-217	15
VST217W0.96R000-4S08		●	0°	4	21.7	0.96 ⁽¹⁾	-	S08	1.9	KEYV-217	15
VST217W1.00R005-4S08		●	0°	4	21.7	1	0.05	S08	2	KEYV-217	15
VST217W1.20R005-4S08		●	0°	4	21.7	1.2 ⁽¹⁾	0.05	S08	4.5	KEYV-217	15
VST217W1.40R005-4S08		●	0°	4	21.7	1.4 ⁽¹⁾	0.05	S08	4.5	KEYV-217	15
VST217W1.57R000-4S08		●	0°	4	21.7	1.57	-	S08	4.5	KEYV-217	15
VST217W1.70R010-4S08		●	0°	4	21.7	1.7 ⁽¹⁾	0.1	S08	4.5	KEYV-217	15
VST217W1.95R020-4S08		●	0°	4	21.7	1.95 ⁽¹⁾	0.2	S08	4.5	KEYV-217	15
VST217W2.00R020-4S08		●	0°	4	21.7	2	0.2	S08	4.5	KEYV-217	15
VST217W2.25R020-4S08		●	0°	4	21.7	2.25 ⁽¹⁾	0.2	S08	4.5	KEYV-217	15
VST217W2.39R020-4S08		●	0°	4	21.7	2.39	0.2	S08	4.5	KEYV-217	15
VST217W2.50R020-4S08	●	●	0°	4	21.7	2.5	0.2	S08	4.5	KEYV-217	15
VST217W2.75R020-4S08		●	0°	4	21.7	2.75 ⁽¹⁾	0.2	S08	4.5	KEYV-217	15
VST217W3.00R020-4S08	●	●	0°	4	21.7	3	0.2	S08	4.5	KEYV-217	15
VST217W3.17R020-4S08		●	0°	4	21.7	3.17	0.2	S08	4.5	KEYV-217	15
VST217W3.25R020-4S08		●	0°	4	21.7	3.25 ⁽¹⁾	0.2	S08	4.5	KEYV-217	15
VST217W4.00R020-4S08		●	0°	4	21.7	4	0.2	S08	4.5	KEYV-217	15
VST217W4.25R020-4S08		●	0°	4	21.7	4.25 ⁽¹⁾	0.2	S08	4.5	KEYV-217	15
VST217W4.75R020-4S08		●	0°	4	21.7	4.75	0.2	S08	4.5	KEYV-217	15
VST217W5.25R020-4S08		●	0°	4	21.7	5.25 ⁽¹⁾	0.2	S08	4.5	KEYV-217	15
VST277W2.50R020-6S10		●	0°	6	27.7	2.5	0.2	S10	6	KEYV-T40L	28
VST277W5.25R020-6S10		●	0°	6	27.7	5.25	0.2	S10	6	KEYV-T40L	28
VST277W10.0R020-6S10		●	0°	6	27.7	10	0.2	S10	6	KEYV-T40L	28

(1) CW is based on DIN471 / 472

* Recommended clamping torque (N·m)

2 pieces per package

● : Line up

VST**A45...

3, 4 flute, for slotting with 45° chamfer

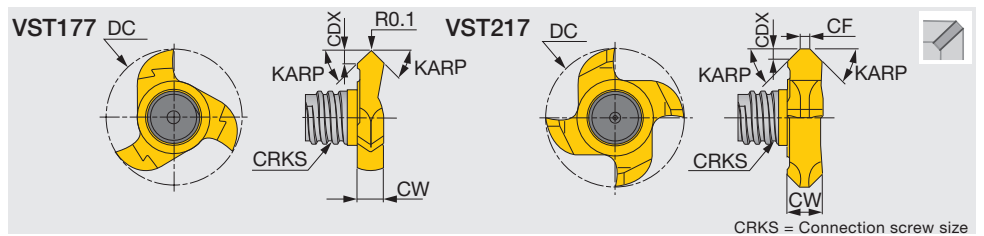

Designation	GH130	NOF	FHA	DC	CW	KARP	CRKS	CDX	CF	Wrench	Torque*
VST177L01.40A45-3S06	●	3	0°	17.7	3.4	45°	S06	1.4	-	KEYV-177	10
VST217L01.70A45-4S08	●	4	0°	21.7	5.5	45°	S08	1.7	1.5	KEYV-217	15

* Recommended clamping torque (N·m)

2 pieces per package

● : Line up

VTB**-06...

6 flute, for T-slotting

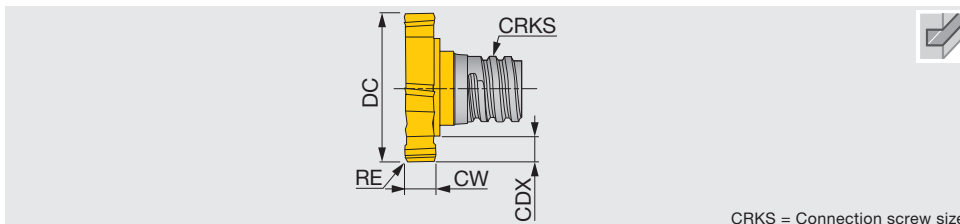

CRKS = Connection screw size

Designation	AH735	GH130	NOF	FHA	DC -0.08 ⁰	CW±0.02	CDX	CRKS	RE	Wrench	Torque*
VTB135W3.00R04-06S05		●	6	0°	13.5	3	2.65	S05	0.4	KEYV-T20	7
VTB135W4.00R04-06S05		●	6	0°	13.5	4	2.65	S05	0.4	KEYV-T20	7
VTB160W2.00R04-06S06		●	6	0°	16	2	2.9	S06	0.4	KEYV-T20	10
VTB160W3.00R04-06S06		●	6	0°	16	3	2.9	S06	0.4	KEYV-T25	10
VTB160W4.00R04-06S06		●	6	0°	16	4	2.9	S06	0.4	KEYV-T25	10
VTB165W2.00R04-06S06		●	6	0°	16.5	2	3.15	S06	0.4	KEYV-T20	10
VTB165W3.00R04-06S06		●	6	0°	16.5	3	3.15	S06	0.4	KEYV-T25	10
VTB165W4.00R04-06S06		●	6	0°	16.5	4	3.15	S06	0.4	KEYV-T25	10
VTB195W4.00R04-06S08		●	6	0°	19.5	4	3.45	S08	0.4	KEYV-T30L	15
VTB195W5.00R04-06S08		●	6	0°	19.5	5	3.45	S08	0.4	KEYV-T30L	15
VTB195W6.00R04-06S08		●	6	0°	19.5	6	3.45	S08	0.4	KEYV-T30L	15
VTB225W5.00R04-06S08		●	6	0°	22.5	5	4.95	S08	0.4	KEYV-T40L	15
VTB225W6.00R04-06S08		●	6	0°	22.5	6	4.95	S08	0.4	KEYV-T40L	15
VTB225W8.00R04-06S08		●	6	0°	22.5	8	4.95	S08	0.4	KEYV-T40L	15
VTB250W6.00R04-06S08		●	6	0°	25	6	5.9	S08	0.4	KEYV-T50L	15
VTB250W8.00R04-06S08		●	6	0°	25	8	5.9	S08	0.4	KEYV-T50L	15
VTB250W5.00R04-06S10		●	6	0°	25	5	4.3	S10	0.4	KEYV-T50L	28
VTB250W6.00R04-06S10	●	●	6	0°	25	6	4.3	S10	0.4	KEYV-T50L	28
VTB250W8.00R04-06S10		●	6	0°	25	8	4.3	S10	0.4	KEYV-T50L	28

* Recommended clamping torque (N·m)
2 pieces per package

● : Line up

VTB**C15-06...

6 flute, for T-slotting with 45° chamfer

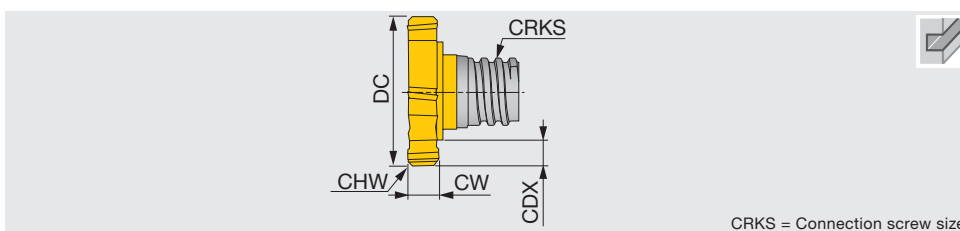

CRKS = Connection screw size

Designation	GH130	NOF	FHA	DC -0.05 ⁰	CW±0.02	CDX	CRKS	CHW	Wrench	Torque*
VTB135W2.00C15-06S05	●	6	0°	13.5	2	2.65	S05	0.15	KEYV-T20	7

* Recommended clamping torque (N·m)
2 pieces per package

● : Line up

STANDARD CUTTING CONDITIONS

Slotting

VST, VTB

ISO	Workpiece material	Hardness	VST		VTB	
			Cutting speed Vc (m/min)	Feed per tooth fz (mm/t)	Cutting speed Vc (m/min)	Feed per tooth fz (mm/t)
P	Carbon steel S45C, S55C, etc. C45, C55, etc.	- 300 HB	80 - 180	0.05 - 0.15	80 - 180	0.08 - 0.18
	Alloy steel SCM440, SCr420, etc. 42CrMo4, 20Cr4, etc.	- 300 HB	60 - 120	0.04 - 0.12	60 - 120	0.05 - 0.15
M	Stainless steel SUS304, SUS316, etc. X5CrNi18-9, X5CrNiMo17-12-2, etc.	- 200 HB	50 - 120	0.04 - 0.12	50 - 120	0.05 - 0.15
K	Grey cast iron FC250, FC300, etc. 250, 300, etc., GG250, GG300, etc.	150 - 250 HB	100 - 200	0.05 - 0.15	100 - 200	0.08 - 0.18
	Ductile cast iron FCD450, etc. 450-10S, etc., GGG450, etc.	150 - 250 HB	100 - 200	0.04 - 0.12	100 - 200	0.05 - 0.15
N	Aluminium alloys Si < 13%	-	200 - 600	0.05 - 0.15	200 - 600	0.08 - 0.18
	Aluminium alloys Si ≥ 13%	-	100 - 300	0.03 - 0.13	100 - 300	0.05 - 0.15
S	Titanium alloys Ti-6Al-4V, etc.	-	40 - 60	0.04 - 0.12	40 - 60	0.05 - 0.15
	Heat-resistant alloys Inconel 718, etc.	-	15 - 35	0.02 - 0.1	15 - 35	0.02 - 0.1

Tolerance of tool diameter

Basic dimensions (mm)		Permissible dimensional deviations (µm)						
>	≤	e8	e9	h6	h7	h9	h10	z9
6	10	-25 -47	-25 -61	0 -9	0 -15	0 -36	0 -58	+78 +42
10	14	-32 -59	-32 -75	0 -11	0 -18	0 -43	0 -70	+93 +50
14	18	-32 -59	-32 -75	0 -11	0 -18	0 -43	0 -70	+103 +60
18	30	-40 -73	-40 -92	0 -13	0 -21	0 -52	0 -84	-

JISB0401-2: 1998 (ISO286-2: 1988) extract

HPAV06-S

2, 3, 4 tooth, roughing - semi finishing, shoulder milling cutter

Indexable modular head

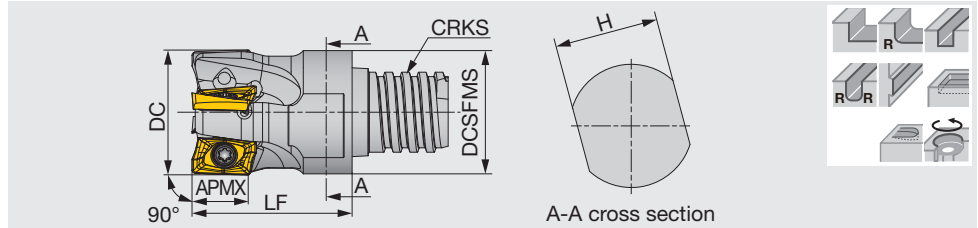

Designation	APMX	DC	CICT	LF	H	DCSFMS	CRKS	WT (kg)	Air hole	Insert
HPAV06M010S05R02 ***	6	10	2	10	8	8	S05	0.01	Without	AVGT06...
HPAV06M010S06R02	6	10	2	16	8	9.8	S06	0.01	Without	AVGT06...
HPAV06M012S08R02	6	12	2	18	10	11.7	S08	0.02	Without	AVGT06...
HPAV06M012S08R03	6	12	3	18	10	11.7	S08	0.02	Without	AVGT06...
HPAV06M016S10R03	6	16	3	20	13	15.4	S10	0.03	Without	AVGT06...
HPAV06M016S10R04	6	16	4	20	13	15.4	S10	0.03	Without	AVGT06...

Applicable shank: VSSD, VTSD, VSC, VSTD, VER

Please use VAD-M adapter to connect TungMeister with a metric thread shank.

*** The wrench size for these heads is different from the ones for the other head types.

Designation	Wrench*
HPAV06M010S...	KEYV-S06
HPAV06M012S...	KEYV-S08
HPAV06M016S...	KEYV-S10

*sold separately

SPARE PARTS

Designation	Clamping screw	Lubricant	Wrench
HPAV06M...	CSPB-2H	M-1000	IP-6DB

*Recommended clamping torque (N·m): CSPB-2H = 0.7

INSERTS

AVGT-MJ

AVGT-AJ

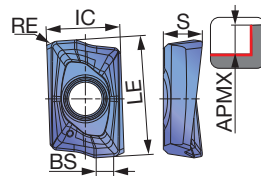

P Steel	☆	☆	★							
M Stainless		☆	★	☆						
K Cast iron	★									
N Non-ferrous							★			
S Superalloys	☆	★								
H Hard materials	★									

★ : First choice
☆ : Second choice

Designation	RE	APMX	Coated				Carbide				LE	IC	S	BS	
			AH120	AH130	AH3135	AH3225	KS05F								
AVGT060300PBER-MJ	0.0	6			●	●						8	5	2.7	1.6
AVGT060302PBER-MJ	0.2	6	●	●	●	●						8	5	2.7	1.5
AVGT060304PBER-MJ	0.4	6	●	●	●	●						8	5	2.7	1.3
AVGT060308PBER-MJ	0.8	6	●	●	●	●						8	5	2.6	0.9
AVGT060300PBFR-AJ	0.0	6					●					8	5	2.7	1.6
AVGT060302PBFR-AJ	0.2	6					●					8	5	2.7	1.5
AVGT060304PBFR-AJ	0.4	6					●					8	5	2.7	1.3
AVGT060308PBFR-AJ	0.8	6					●					8	5	2.6	0.9

● : Will be released in December 2021

● : Line up

STANDARD CUTTING CONDITIONS

HPAV06-S

ISO	Workpiece materials	Hardness	Priority	Grades	Cutting speed Vc (m/min)	Feed per tooth fz (mm/t)	
P	Low carbon steel S15C / C15E4, SS400 / E275A, etc.	- 200 HB	First choice	AH3225	230 - 430	0.07 - 0.12	
	Carbon steel and alloy steel S55C / C55, SCM440 / 42CrMo4, etc.	- 300 HB	First choice	AH3225	150 - 350	0.07 - 0.12	
	Prehardend steel NAK80, PX5, etc.	30 - 40 HRC	First choice	AH3225	100 - 230	0.07 - 0.12	
M	Stainless steel SUS304 / X5CrNi18-9, SUS316 / X5CrNiMo17-12-3, etc.	-	First choice	AH3135	150 - 220	0.06 - 0.1	
K	Grey cast iron FC250 / 250, FC300 / 300, etc.	150 - 250 HB	First choice	AH120	200 - 330	0.07 - 0.12	
	Ductile cast iron FCD400, FCD600 / 600-3, etc.	150 - 250 HB	First choice	AH120	150 - 240	0.07 - 0.12	
N	Aluminium alloys Si < 13%	-	First choice	KS05F	650 - 1000	0.07 - 0.12	
	Aluminium alloys Si ≥ 13%	-	First choice	KS05F	100 - 230	0.04 - 0.12	
S	Titanium alloys Ti-6Al-4V, etc.	-	First choice	AH130	40 - 90	0.04 - 0.1	
	Superalloys Inconel718, etc.	-	First choice	AH130	45 - 65	0.04 - 0.09	
H	Hardened steel	SKD61 / X40CrMoV5-1, etc.	40 - 50 HRC	First choice	AH120	45 - 70	0.04 - 0.08
		SKD11 / X153CrMoV12, etc.	50 - 60 HRC	First choice	AH120	40 - 65	0.04 - 0.06

MACHINING APPLICATIONS

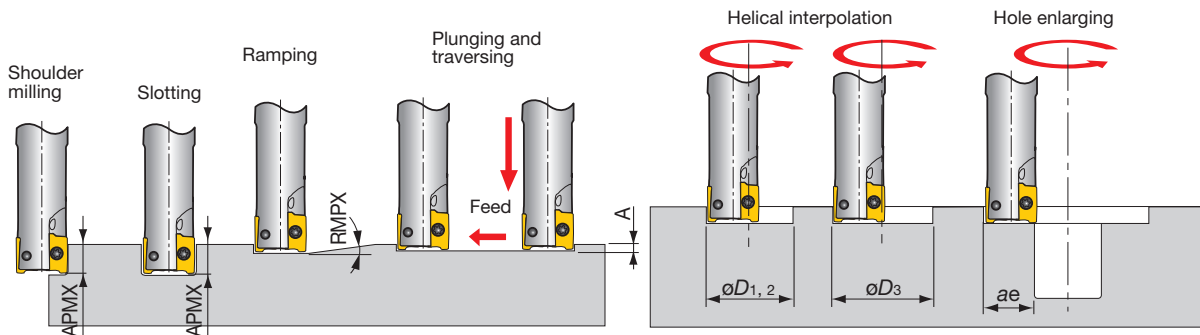

Designation	DC	Max. depth of cut	Max. ramping angle	Max. plunging	Min. machining	Max. machining		Max. cutting width in enlarging
		APMX	RMPX	A	øD ₁	øD ₂	øD ₃ *	ae
HPAV06M010...	10	6	3°	0.3	15	19	18	9.5
HPAV06M012...	12	6	3°	0.3	18	23	22	11.5
HPAV06M016...	16	6	2°	0.3	28	31	30	15.5

*Flat bottom hole

When clamping the insert, please confirm that there is no gap between the cutter body and the insert as shown in the picture.

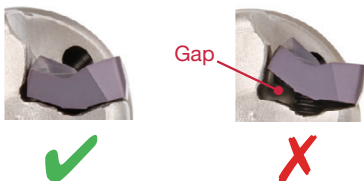

ISO metric

VMT***IS

3 - 6 flute, full profile, for internal thread



Threading

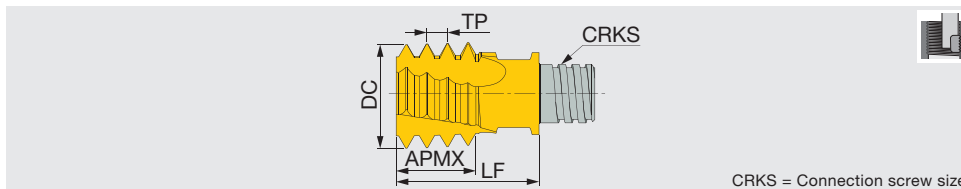

CRKS = Connection screw size

Designation	TP	Application range		DC	NOF	APMX	LF	CRKS	Grade	Wrench	Torque*
		Coarse	Fine								
VMT100L06IS07-4S05	0.75	-	≥M12	10	4	6	12.8	S05	AH725	KEYV-S05	7
VMT100L06IS10-4S05	1	-	≥M12	10	4	6	12.8	S05	AH725	KEYV-S05	7
VMT100L06IS15-4S05	1.5	-	≥M14	10	4	6	12.8	S05	AH725	KEYV-S05	7
VMT120L08IS15-4S06	1.5	-	≥M16	12	4	7.6	14.3	S06	AH725	KEYV-S06	10
VMT120L08IS20-4S06	2	M16	≥M17	12	4	8	14.3	S06	AH725	KEYV-S06	10
VMT160L12IS15-6S08	1.5	-	≥M20	16	6	12	19	S08	AH725	KEYV-T30L	15
VMT160L12IS20-5S08	2	-	≥M19	16	5	12	19	S08	AH725	KEYV-T30L	15
VMT154L13IS25-5S08	2.5	M20	≥M22	15.4	5	12.7	20	S08	AH725	KEYV-S08	15
VMT160L12IS30-3S08	3	M24	≥M25	16	3	12	19	S08	AH725	KEYV-T30L	15

* Recommended clamping torque (N·m)
2 pieces per package

Unified

VMT***UN

3, 4, 5 flute, full profile, for internal thread



Threading

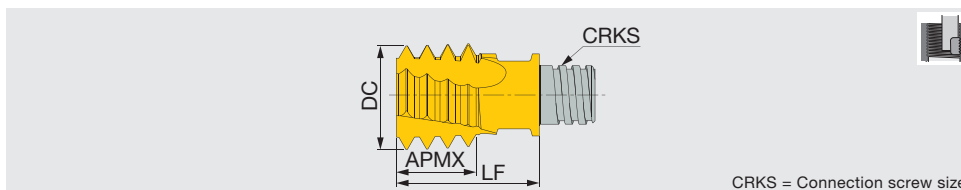

CRKS = Connection screw size

Designation	TPI	Application range			DC	NOF	APMX	LF	CRKS	Grade	Wrench	Torque*
		UNC	UNF	UNEF								
VMT100L06UN24-4S05	24	-	-	9/16-5/8	10	4	5.3	12.8	S05	AH725	KEYV-S05	7
VMT100L06UN20-4S05	20	-	1/2	-	10	4	5.1	12.8	S05	AH725	KEYV-S05	7
VMT100L06UN18-4S05	18	-	9/16-5/8	1 1/8-1 5/8	10	4	5.6	12.8	S05	AH725	KEYV-S05	7
VMT120L08UN16-4S06	16	-	3/4	-	12	4	8	14.3	S06	AH725	KEYV-S06	10
VMT120L10UN14-4S06	14	-	7/8	-	12	4	9	14.3	S06	AH725	KEYV-T25	10
VMT160L13UN12-5S08	12	-	1-1 1/2	-	16	5	12.7	19	S08	AH725	KEYV-T30L	15
VMT150L13UN10-4S08	10	3/4	-	-	15.4	4	12.7	19	S08	AH725	KEYV-T30L	15
VMT160L11UN09-3S08	9	7/8	-	-	16	3	11.3	19	S08	AH725	KEYV-T30L	15
VMT160L13UN08-3S08	8	1	-	-	16	3	12.7	20	S08	AH725	KEYV-S08	15

* Recommended clamping torque (N·m)
2 pieces per package

Whitworth

VMT***W

4 flute, full profile, for internal/external thread



Threading

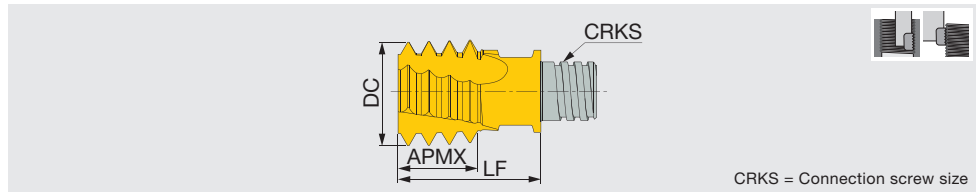

CRKS = Connection screw size

Designation	TPI	Application range	DC	NOF	APMX	LF	CRKS	Grade	Wrench	Torque*
VMT100L06W19-4S05	19	1/4-3/8	10	4	5.3	12.8	S05	AH725	KEYV-S05	7
VMT160L13W14-4S08	14	1/2-7/8	16	4	12.7	20	S08	AH725	KEYV-S08	15
VMT160L11W11-4S08	11	≥1	16	4	11.6	19	S08	AH725	KEYV-T30L	15

* Recommended clamping torque (N·m)
2 pieces per package

60° partial profile

VTR***IS

3, 4 flute, partial profile, for internal/external thread



Threading

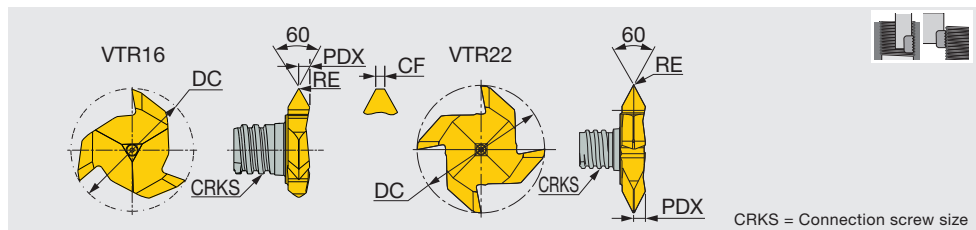

CRKS = Connection screw size

Designation	TP		Smallest Possible thread	DC	NOF	RE	CF	PDX	CRKS	Grade	Wrench	Torque*
	TPN	TPX										
VTR160L12IS05-3S06	0.5	2	M20	15.7	3	-	0.05	1.4	S06	GH130	KEYV-177	10
VTR160L12IS15-3S06	1.5	2	M22	15.7	3	0.05	-	1.4	S06	GH130	KEYV-177	10
VTR220L28IS30-4S08	3	4.5	M36	21.7	4	0.2	-	2.8	S08	GH130	KEYV-217	15

* Recommended clamping torque (N·m)
2 pieces per package

55° partial profile

VTR***W

4 flute, partial profile, for internal/external thread



Threading

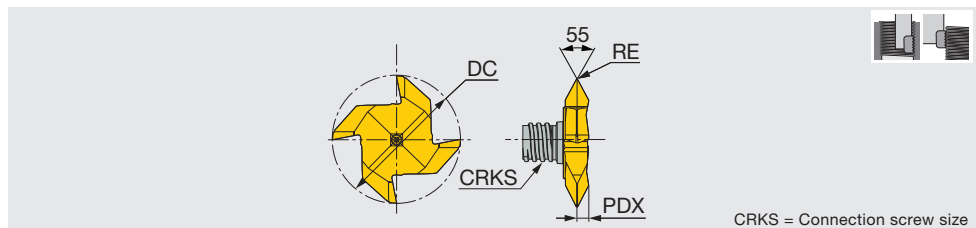

CRKS = Connection screw size

Designation	TPI		Smallest Possible thread	DC	NOF	RE	PDX	CRKS	Grade	Wrench	Torque*
	TPIN	TPIX									
VTR220L24W14-4S08	14	11	3/4	21.7	4	0.2	2.4	S08	GH130	KEYV-217	15

* Recommended clamping torque (N·m)
2 pieces per package

STANDARD CUTTING CONDITIONS

Threading

VMT, VTR

ISO	Material	Condition	Tensile strength [N/mm ²]	Hardness HB	Cutting speed (m/min)		Tool dia. (mm)			
					AH725	ø10	ø12	ø15.4, ø15.7, ø16	ø21.7	
P	Non-alloy steel and cast steel, free cutting steel	< 0.25 %C	Annealed	420	125	100 - 250	0.08	0.09	0.12	0.15
		≥ 0.25 %C	Annealed	650	190	80 - 210	0.08	0.09	0.12	0.15
		< 0.55 %C	Quenched and tempered	850	250	65 - 170				
		≥ 0.55 %C	Annealed	750	220	110 - 180	0.07	0.08	0.1	0.12
	Low alloy steel and cast steel (less than 5% of alloying elements)	Quenched and tempered	1000	300	95 - 160	0.07	0.08	0.1	0.12	
		Annealed	600	200	90 - 160	0.05	0.05	0.07	0.08	
		Quenched and tempered	930	275	65 - 200	0.05	0.05	0.07	0.08	
			1000	300	70 - 210	0.05	0.05	0.07	0.08	
	High alloyed steel, cast steel, and tool steel	Annealed	680	200	130 - 170	0.05	0.05	0.07	0.08	
		Quenched and tempered	1100	325	75 - 100	0.05	0.05	0.07	0.08	
Stainless steel and cast steel	Ferritic/martensitic	680	200	110 - 170	0.05	0.05	0.07	0.08		
	Martensitic	820	240	70 - 155	0.05	0.05	0.07	0.08		
M	Stainless steel	Annealed	600	180	85 - 100	0.05	0.05	0.07	0.08	
K	Cast iron nodular (GGG)	Ferritic/martensitic		180	120 - 160	0.08	0.09	0.12	0.15	
		Pearlitic		260	75 - 160	0.08	0.09	0.12	0.15	
	Grey cast iron (GG)	Ferritic		160	70 - 150	0.08	0.09	0.12	0.15	
		Pearlitic		250	110 - 140	0.08	0.09	0.12	0.15	
	Malleable cast iron	Ferritic		130	120 - 160	0.08	0.09	0.12	0.15	
Pearlitic			230	110 - 140	0.08	0.09	0.21	0.15		
N	Aluminium-wrought alloy	Not cureable		60	160 - 300	0.08	0.09	0.12	0.15	
		Cured		100						
	Aluminium-cast, alloyed	≤12% Si	Not cureable		75	150 - 350	0.08	0.09	0.12	0.15
		>12% Si	High temperature		130	100 - 250	0.05	0.05	0.07	0.08
	Copper alloys	>1% Pb	Free cutting		110					
			Brass		90					
	Non-metallic		Duroplastics, fiber plastics			100 - 400	0.11	0.12	0.15	0.18
		Hard rubber								
S	High temp. alloys	Fe based	Annealed		200					
			Cured		280					
		Ni or Co based	Annealed		250	20 - 80	0.03	0.03	0.04	0.04
			Cured		350					
	Titanium Ti alloys	Cast		320						
			RM 400							
H	Hardened steel	Alpha+beta alloys cured	RM 1050		20 - 80	0.03	0.03	0.04	0.04	
		Hardened		55 HRC	55 - 65					
	Chilled cast iron	Hardened		60 HRC	45 - 55					
		Cast		400	90 - 105					
Cast iron	Hardened		55 HRC	55 - 65						

Thread Milling CNC Program for Internal Thread

Right-hand thread (climb milling) from bottom up. Program is based on tool center.

This method of programming needs no tool radius compensation value, other than an offset for wear.

$$A = \frac{D_o - D}{2}$$

A = Radius of tool path
 D_o = Major thread diameter
 D = Cutting diameter

General Program

```
G90 G00 G54 G43 H1X0 Y0 Z10 S (n : Number of revolutions)
G00 Z-(to thread depth)
G01 G91 G41 D1 X (A/2) Y-(A/2) Z0 F (Center of tool)
G03 X(A/2) Y(A/2) R (A/2) Z(1/8 pitch) F (Cutting edge)
G03 X0 Y0 I -(A) J0 Z (pitch)
G03 X-(A/2) Y(A/2) R (A/2) Z(1/8 pitch)
G01 G40 X -(A/2) Y-(A/2) Z0
G90 X0 Y0 Z0
```

Internal Thread

Example: M20x2.0 IN-RH (Thread depth 20 mm)

Tool : MTEC1010C27 2.0ISO

(Cutting dia. 10 mm)

$$A = (D_o - D) / 2 = (20 - 10) / 2 = 5$$

$$A/2 = 2.5$$

(Tool compensation of radius=0)

```
G90 G0 G54 G43 G17 H1X0 Y0 Z10 S4000
G0 Z-20
G01 G91 G41 D1X 2.5 Y-2.5 Z0 F840
G03 X2.5 Y2.5 R2.5 Z0.25 F420
G03 X0 Y0 I-5.0 J0 Z2.0
G03 X-2.5 Y2.5 R2.5 Z0.25
G01 G40 X-2.5 Y-2.5 Z0
G90 G0 X0 Y0 Z0
M30
%
```

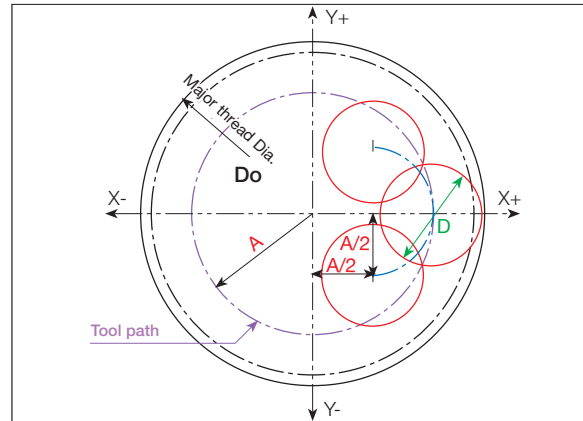

$$F \text{ (Center of tool)} = n \times f \times z$$

$$F \text{ (Cutting edge)} = \frac{D_o - D}{D_o} \times n \times f \times z$$

n : Number of revolutions
 f : rev / tooth
 z : Number of edge

Internal Thread

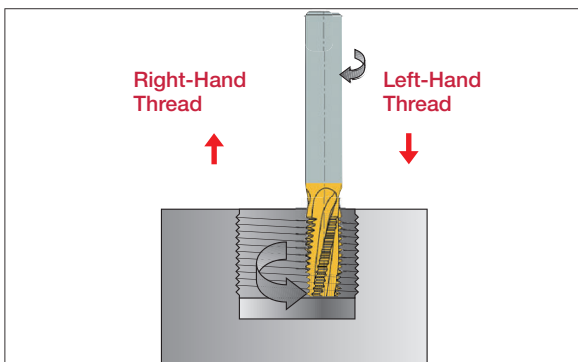

External Thread

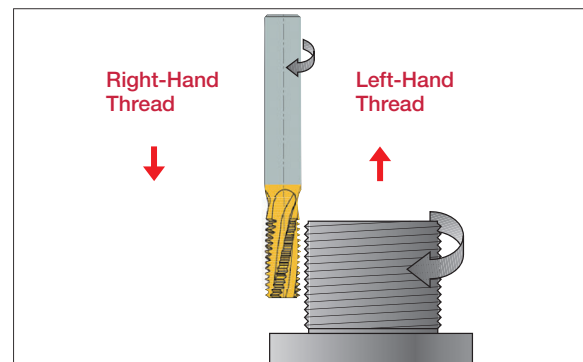

A thread milling operation is applicable for thread cutting in non-symmetrical parts utilizing the advantage of helical interpolation programs on modern machining centers.



For more details, please check ThreadMilling advisor.

SHANKS

VSSD**-W-A...

Straight shank and neck with coolant hole

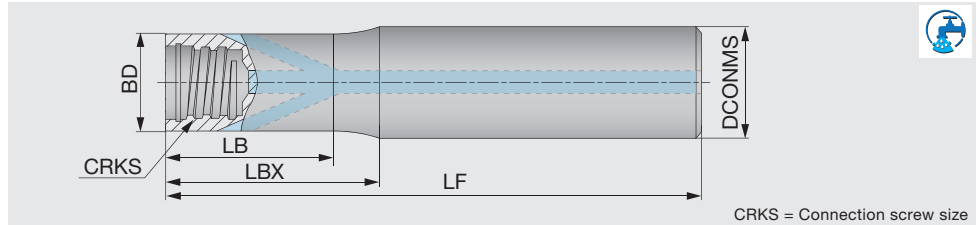

CRKS = Connection screw size

Designation	DCONMS	BD	LF	LBX	LB	CRKS	Shank material
VSSD10L070S06-W-A	10	9.6	70	20	19	S06	Tungsten
VSSD10L090S06-W-A	10	9.6	90	40	39	S06	Tungsten
VSSD10L110S06-W-A	10	9.6	110	60	59	S06	Tungsten
VSSD12L070S08-W-A	12	11.5	70	20	19	S08	Tungsten
VSSD12L090S08-W-A	12	11.5	90	40	39	S08	Tungsten
VSSD12L110S08-W-A	12	11.5	110	60	59	S08	Tungsten
VSSD12L130S08-W-A	12	11.5	130	80	79	S08	Tungsten
VSSD16L070S10-W-A	16	15.2	70	20	18.5	S10	Tungsten
VSSD16L090S10-W-A	16	15.2	90	40	36.5	S10	Tungsten
VSSD16L110S10-W-A	16	15.2	110	60	58.5	S10	Tungsten
VSSD16L130S10-W-A	16	15.2	130	80	78.5	S10	Tungsten
VSSD20L090S12-W-A	20	18.3	90	40	37	S12	Tungsten
VSSD20L130S12-W-A	20	18.3	130	80	77	S12	Tungsten

VSSD...

High rigidity shank

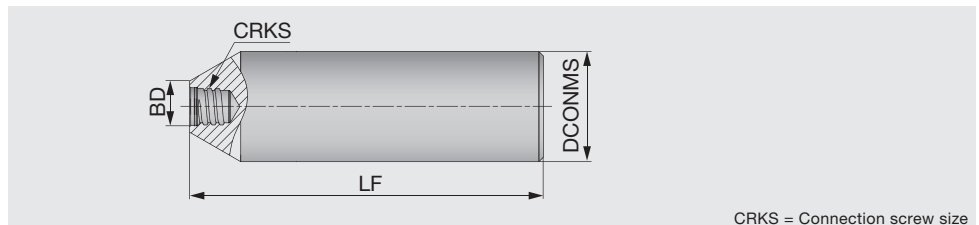

CRKS = Connection screw size

	Designation	DCONMS	BD	LF	CRKS	Shank shape	Shank material
New	VSSD06L050S04-S	6	5.8	50	S04	Cylindrical	Steel
New	VSSD06L060S04-C	6	5.8	60	S04	Cylindrical	Carbide
New	VSSD08L050S04-S	8	5.8	50	S04	Cylindrical	Steel
New	VSSD08L060S04-C	8	5.8	60	S04	Cylindrical	Carbide
	VSSD10L055S05-S	10	7.6	55	S05	Cylindrical	Steel
	VSSD12L065S06-S	12	9.6	65	S06	Cylindrical	Steel
	VSSD16L065S08-S	16	11.6	65	S08	Cylindrical	Steel
	VSSD20L070S10-S	20	15.3	70	S10	Cylindrical	Steel
	VSSD25L075S12-S	25	18.3	75	S12	Cylindrical	Steel
New	VSSD32L100S15-S	32	23.9	100	S15	Cylindrical	Steel
New	VSSD40L100S21-S	40	30	100	S21	Cylindrical	Steel

VSSD...

Straight neck and cylindrical shank

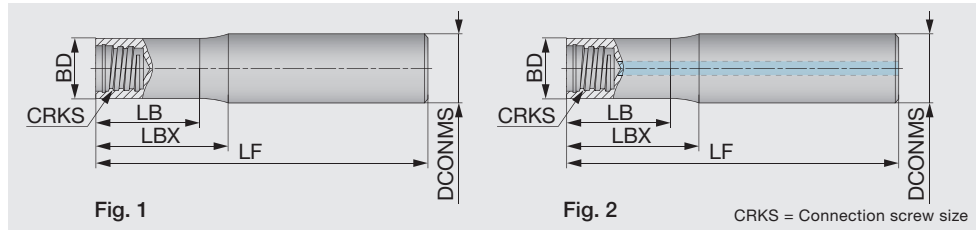

Designation	DCONMS	BD	LF	LBX	LB	CRKS	Shank shape	Shank material	Fig.
VSSD08L060S05-S	8	7.6	60	15	12.8	S05	Cylindrical	Steel	1
VSSD08L070S05-C	8	7.6	70	20	19	S05	Cylindrical	Carbide	1
VSSD08L090S05-C	8	7.6	90	40	39	S05	Cylindrical	Carbide	1
VSSD08L110S05-C	8	7.6	110	60	59	S05	Cylindrical	Carbide	1
VSSD10L070S06-C	10	9.6	70	20	18.5	S06	Cylindrical	Carbide	1
VSSD10L075S06-S	10	9.6	75	20	19.4	S06	Cylindrical	Steel	1
VSSD10L090S06-C	10	9.6	90	40	38.5	S06	Cylindrical	Carbide	1
VSSD10L110S06-C	10	9.6	110	60	58.5	S06	Cylindrical	Carbide	1
VSSD10L150S06-C	10	9.6	150	100	98.5	S06	Cylindrical	Carbide	1
VSSD12L070S08-C	12	11.5	70	20	17	S08	Cylindrical	Carbide	1
New VSSD12L070S08-C-A	12	11.5	70	20	17	S08	Cylindrical	Carbide	2
VSSD12L090S08-C	12	11.5	90	40	37	S08	Cylindrical	Carbide	1
VSSD12L090S08-S	12	11.5	90	16	13.6	S08	Cylindrical	Steel	1
New VSSD12L090S08-S-A	12	11.5	90	16	13.6	S08	Cylindrical	Steel	2
New VSSD12L090LS08-C-A	12	11.5	90	40	37	S08	Cylindrical	Carbide	2
New VSSD12L090LS08-S-A	12	11.5	90	42	37	S08	Cylindrical	Steel	2
VSSD12L110S08-C	12	11.5	110	60	58	S08	Cylindrical	Carbide	1
New VSSD12L110S08-C-A	12	11.5	110	60	57	S08	Cylindrical	Carbide	2
VSSD12L130S08-C	12	11.5	130	80	78	S08	Cylindrical	Carbide	1
New VSSD12L130S08-C-A	12	11.5	130	80	77	S08	Cylindrical	Carbide	2
VSSD16L090S10-C	16	15.2	90	40	38	S10	Cylindrical	Carbide	1
New VSSD16L090S10-C-A	16	15.2	90	40	38	S10	Cylindrical	Carbide	2
VSSD16L100S10-S	16	15.2	100	20	18	S10	Cylindrical	Steel	1
New VSSD16L100S10-S-A	16	15.2	100	20	18	S10	Cylindrical	Steel	2
New VSSD16L100LS10-S-A	16	15.2	100	42	38	S10	Cylindrical	Steel	2
VSSD16L110S10-C	16	15.2	110	60	58	S10	Cylindrical	Carbide	1
New VSSD16L110S10-C-A	16	15.2	110	60	58	S10	Cylindrical	Carbide	2
VSSD16L130S10-C	16	15.2	130	80	78	S10	Cylindrical	Carbide	1
New VSSD16L130S10-C-A	16	15.2	130	80	78	S10	Cylindrical	Carbide	2
VSSD16L150S10-C	16	15.2	150	100	98	S10	Cylindrical	Carbide	1
VSSD20L090S12-C	20	18.3	90	40	37	S12	Cylindrical	Carbide	1
VSSD20L120S12-S	20	18.3	120	25	20.5	S12	Cylindrical	Steel	1
VSSD20L130S12-C	20	18.3	130	80	77	S12	Cylindrical	Carbide	1
VSSD20L200S12-C	20	18.3	200	120	117	S12	Cylindrical	Carbide	1
VSSD25L120S15-C	25	23.9	120	60	58	S15	Cylindrical	Carbide	1
VSSD25L135S15-S	25	23.9	135	35	33	S15	Cylindrical	Steel	1
VSSD25L170S15-C	25	23.9	170	100	98	S15	Cylindrical	Carbide	1
VSSD25L250S15-C	25	23.9	250	150	148	S15	Cylindrical	Carbide	1
New VSSD32L100S21-S	32	30	100	35	32	S21	Cylindrical	Steel	1
New VSSD32L150S21-S	32	30	150	54	50	S21	Cylindrical	Steel	1

VSSD**-W...

Straight neck and weldon shank

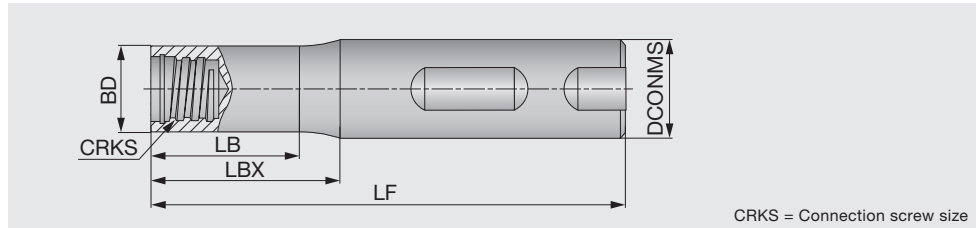

CRKS = Connection screw size

Designation	DCONMS	BD	LF	LBX	LB	CRKS	Shank shape	Shank material
VSSD12L055W05-S	12	7.6	55	3.8	-	S05	Weldon	Steel
VSSD16L065W06-S	16	9.6	65	6	-	S06	Weldon	Steel
VSSD16L065W08-S	16	11.5	65	4	-	S08	Weldon	Steel
VSSD20L070W10-S	20	15.2	70	4	-	S10	Weldon	Steel
VSSD25L075W12-S	25	18.3	75	6	-	S12	Weldon	Steel

VTSD...

Straight shank and taper neck

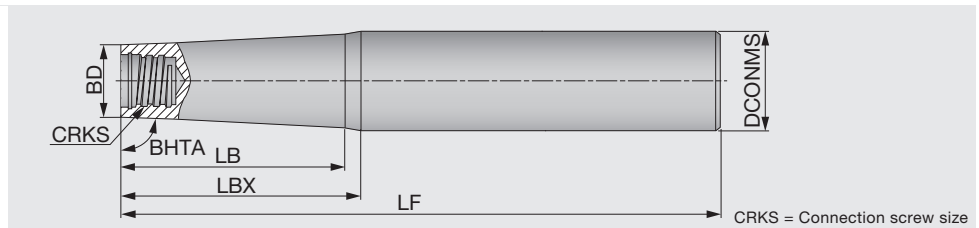

CRKS = Connection screw size

Designation	BHTA	DCONMS	BD	LF	LBX	LB	CRKS	Shank material
New VTSD08L080S04-S	87.4°	8	5.8	80	24	-	S04	Steel
VTSD12L080S05-S	85°	12	7.6	80	25	-	S05	Steel
VTSD12L100S05-S	89°	12	7.6	100	35	29	S05	Steel
VTSD12L110S05-C	89°	12	7.6	110	60	56	S05	Carbide
VTSD12L130S05-C	89°	12	7.6	130	80	77	S05	Carbide
VTSD16L125S06-S	85°	16	9.6	125	34	31	S06	Steel
VTSD16L130S08-C	89°	16	11.5	130	80	76.5	S08	Carbide
VTSD16L140S08-S	85°	16	11.5	140	22	19	S08	Steel
VTSD16L150S05-C	89°	16	7.6	150	100	91	S05	Carbide
VTSD16L150S06-C	89°	16	9.6	150	100	94.5	S06	Carbide
VTSD16L150S08-C	89°	16	11.5	150	100	98	S08	Carbide
VTSD16L160S06-S	89°	16	9.6	160	55	46.5	S06	Steel
VTSD16L170S06-C	89°	16	9.6	170	120	116.5	S06	Carbide
VTSD20L140S10-S	85°	20	15.2	140	27.5	-	S10	Steel
VTSD20L170S08-C	89°	20	11.5	170	120	112	S08	Carbide
VTSD20L170S08-S	89°	20	11.5	170	80	69.5	S08	Steel
VTSD20L170S10-C	89°	20	15.2	170	120	119	S10	Carbide
VTSD20L190S10-C	89°	20	15.2	190	140	-	S10	Carbide
VTSD20L190S10-S	89°	20	15.2	190	80	73	S10	Steel
VTSD20L210S10-C	89°	20	15.2	210	160	-	S10	Carbide
VTSD25L160S12-S	85°	25	18.3	160	40	-	S12	Steel
VTSD25L170S10-S	85°	25	15.2	170	56	-	S10	Steel
VTSD25L180S12-C	89°	25	18.3	180	120	115	S12	Carbide
VTSD25L210S12-S	89°	25	18.3	210	100	94.5	S12	Steel
VTSD25L250S12-C	89°	25	18.3	250	140	136.5	S12	Carbide
VTSD32L155S15-S	85°	32	23.9	155	45	-	S15	Steel
VTSD32L190S12-S	85°	32	18.3	190	80	-	S12	Steel
VTSD32L220S15-S	88°	32	23.9	220	100	-	S15	Steel
VTSD32L250S15-C	89°	32	23.9	250	150	145	S15	Carbide
VTSD32L300S15-C	89°	32	23.9	300	200	198	S15	Carbide
New VTSD40L150S21-S	85°	40	30	150	57	-	S21	Steel

VTSD**-W-A...

Straight shank and taper neck with coolant hole

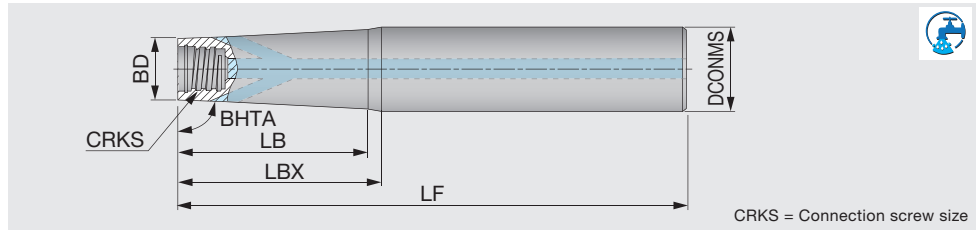

CRKS = Connection screw size

Designation	BHTA	DCONMS	BD	LF	LBX	LB	CRKS	Shank material
VTSD12L110S06-W-A	89°	12	9.6	110	60	59	S06	Tungsten
VTSD16L170S06-W-A	89°	16	9.6	170	120	116	S06	Tungsten

VSC...

Straight shank for VST type slotting heads

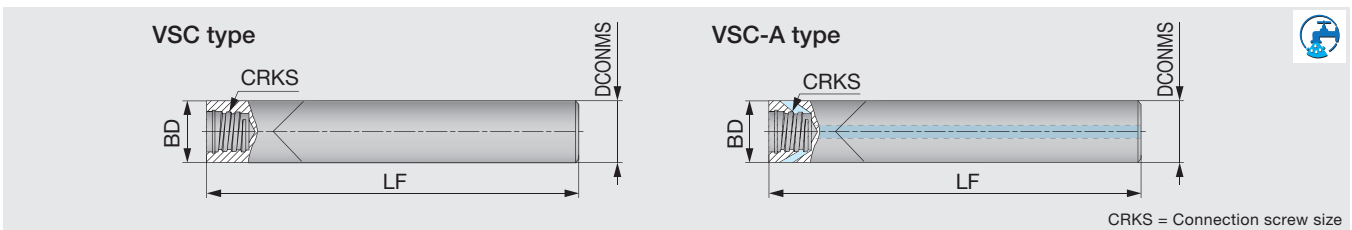

CRKS = Connection screw size

Designation	DCONMS	BD	LF	CRKS	Air hole	Shank material
VSC100L100S06-C	10	10	100	S06	without	Carbide
VSC120L100S08-C-A	12	12	100	S08	with	Carbide

For VSC-C type shank, just VST slotting head is recommended.

If other heads are used on the VSC-C shank, the depth of cut must be smaller than the max. ap in each head.

The VSC-C type shank does not have external clearance, so the shank may interfere with the work piece.

VSTD...

Straight shank for VTB type T-slotting heads

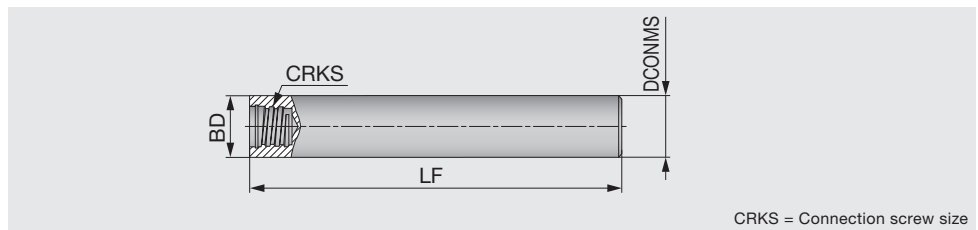

CRKS = Connection screw size

Designation	DCONMS	BD	LF	CRKS	Shank material
New VSTD06L070S04-S	6	6	70	S04	Steel
VSTD08L070S05-S	8	8	70	S05	Steel
VSTD10L080S06-S	10	10	80	S06	Steel
VSTD12L090S08-S	12	12	90	S08	Steel
VSTD16L100S10-S	16	16	100	S10	Steel

For VSTD type shank, just VTB T-slotting head is recommended.

If other heads are used on the VSTD shank, the depth of cut must be smaller than the max. ap in each head.

The VSTD type shank does not have external clearance, so the shank may interfere with the work piece.

VAD**-M...

TungFlex conversion adaptor

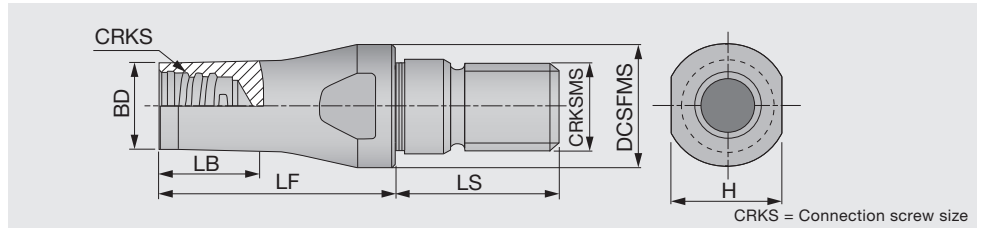

CRKS = Connection screw size

Designation	BD	DCSFMS	LF	LS	LB	CRKS	CRKSMS	H	Shank material
VAD130L016S08-S-M8	11.7	13	16	17.5	6	S08	M8	11	Steel
VAD130L025S08-S-M8	11.7	13	25	17.5	20	S08	M8	11	Steel
VAD180L020S08-S-M10	11.7	18	20	20	12	S08	M10	13	Steel
VAD180L025S08-S-M10	11.7	18	25	20	15	S08	M10	11	Steel
VAD210L020S08-S-M12	11.7	21	20	20	10	S08	M12	12.75	Steel
VAD210L025S08-S-M12	11.7	21	25	20	13	S08	M12	12.75	Steel

VER...

Straight neck with ER11/16 collet

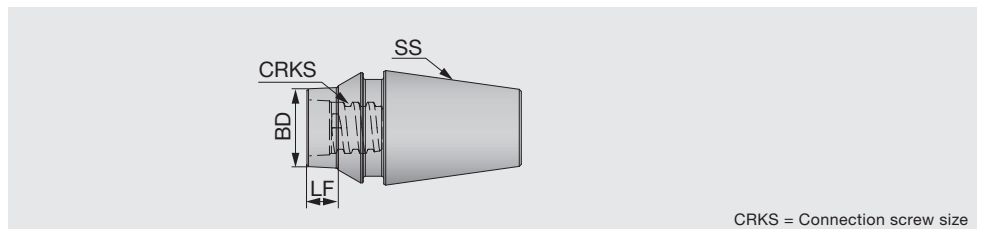

CRKS = Connection screw size

Designation	SS	BD	LF	CRKS	Shank material
New VER11AL006S04-S	ER11	5.8	6	S04	Steel
New VER11AL006S05-S	ER11	7.9	6	S05	Steel
VER11CL006S05-S ⁽¹⁾	ER11	7.92	6	S05	Steel
New VER11AL020S05-S	ER11	7.9	20	S05	Steel
VER11CL020S05-S ⁽¹⁾	ER11	7.92	20	S05	Steel
New VER16AL012S05-S	ER16	7.9	12	S05	Steel
VER16CL012S05-S ⁽¹⁾	ER16	7.92	12	S05	Steel
New VER16AL020S05-S	ER16	7.9	20	S05	Steel
VER16CL020S05-S ⁽¹⁾	ER16	7.92	20	S05	Steel
New VER16AL010S06-S	ER16	9.9	10	S06	Steel
VER16CL010S06-S ⁽¹⁾	ER16	9.92	10	S06	Steel
New VER16AL020S06-S	ER16	9.9	20	S06	Steel
VER16CL020S06-S ⁽¹⁾	ER16	9.92	20	S06	Steel
New VER16AL006S08-S	ER16	11.6	6	S08	Steel
VER16CL006S08-S ⁽¹⁾	ER16	11.6	6	S08	Steel
New VER16AL020S08-S	ER16	11.6	20	S08	Steel
VER16CL020S08-S ⁽¹⁾	ER16	11.6	20	S08	Steel

(1) To be discontinued in 2021

DESIGNATION SYSTEM

Shank

V **SS** **D10** **L070** **S** **06** - **W** - **A**

1 2 3 4 5 6 7 8

1 Series	
V	TungMeister

2 Shank type	
SS	Straight neck
TS	Taper neck
SC	Slotting
ST	T-slotting
AD	TungFlex adapter
ER	ER collet holder

3 Shank diameter (mm)	
D06	ø6
D08	ø8
D10	ø10
D12	ø12
D16	ø16
D20	ø20
D25	ø25
D32	ø32
VSC, VAD type	
100	ø10
120	ø12
130	ø13
180	ø18
210	ø21
VER type	
11A	Collet size
16A	Collet size

4 Length (mm)	
L070	70

5 Shape of shank	
S	Cylindrical
W	Weldon

6 Connection screw size	
04	S04
05	S05
06	S06
08	S08
10	S10
12	S12
15	S15
21	S21

7 Shank material	
S	Steel
C	Carbide
W	Tungsten

8 Additional feature	
A	with coolant hole
M	Thread size (TungFlex adapters)

Head

- Square endmill

V **E** **E** **080** **L05.0** **R00** - **03** **S05**

1 2 3 4 5 6 7 8 9

- Ball nose endmill

V **B** **D** **200** **L15.0** - **BG** - **04** **S12**

1 2 3 4 5 6 7 8 9

1 Series	
V	TungMeister

2 Cutting edge	
E	Square
B	Ball
R	Radius
FX	High feed
CA	Chamfering
CP	Spot drilling
DS	Spot drill with helical flutes
CW	Chamfering (front and back)
CR	R chamfering
GC	Counterboring
DP	Center drilling
S	Slotting
TB	T-slotting
FM	Face milling
BO	Taper barrel
BN	Bull nose
BL	Lens
MT	Threading (full profile)
TR	Threading (partial profile)

3 Helix angle / Rake face	
B	0°
C	15°
D	30°, 37°, 47°
E	38°, 45°, 50°
F	60°
H	43°
T	Land

4 Diameter (mm)	
060	ø6
200	ø20

5 Cutting edge length (mm)	
Length	
L07.0	7
L15.0	15
Groove width	
W1.50	1.5
W1.57	1.57
W10.0	10





6 Corner shape / Angle	
Nose radius	
R00	Sharp edge
R005	R0.05
R01	R0.1
R05	R0.5
R10	R1.0
Chamfer type	
C15	0.15 x 45°
C30	0.3 x 45°
C60	0.6 x 45°
Chamfering head	
A30	30°
A60	60°
R chamfering head	
R10	R1.0
R16	R1.6
Ball nose	
SG	Sphere / high precision
BM	Ball / general purpose
BG	Ball / high precision
Threading	
IS**	ISO metric, pitch**
UN**	Unified, **TPI
W**	Whitworth, pitch**

7 Additional feature	
I	Irregular pitch (or Intermittent edge)
A	for aluminium
R	Serrated edge
C	Combined edge

8 The number of flutes	
General	
02	2
06	6
Slotting head VST type	
3	3
4	4

9 Connection screw size	
S04	S04
S05	S05
S06	S06
S08	S08
S10	S10
S12	S12
S15	S15
S21	S21

WRENCH

Appearance	Designation	Connection screw size	Torque (N-m)	Applicable head
	KEYV-S05	S04	4	Square Ball Radius Drilling Chamfering Counterboring Barrel Lens Bull nose Indexable modular head
		S05	7	
	KEYV-S06	S06	10	
	KEYV-S08	S08	15	
	KEYV-S10	S10	28	
	KEYV-S12	S12	28	
	KEYV-W20	S15	40	
	KS-24	S21	110	Square
	KEYV-177	S06	10	Slotting VST Threading VTR
	KEYV-217	S08	15	
	KEYV-T20	S05	7	Slotting VTB Face mill
		S06	10	
	KEYV-T25	S06	10	
	KEYV-T30L	S08	15	
	KEYV-T40L	S08	15	Slotting VST, VTB Face mill
		S10	28	
	KEYV-T50L	S08	15	Slotting VTB Face mill
S10		28		

Note: Wrenches are sold separately.

TORQUE WRENCHES







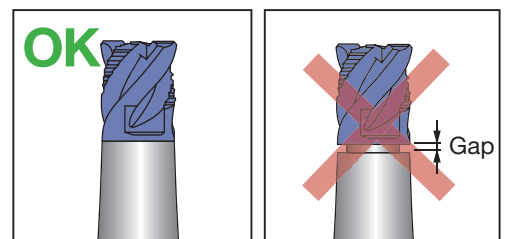





Appearance		Designation	Stock	Connection screw size	TM Head description	Torque (N-m)
Handle		TORQUEWRENCH5-50NM9x12	●	-	-	5 - 50
Open wrenches for cylindrical heads		TM-WRENCH-6-05	●	S05	VEH, VED, VEE, VEE-I, VEE-R, VEE-C, VEE-A,	7
		TM-WRENCH-8-06	●	S06	VFX**-04/06, VRD,	10
		TM-WRENCH-10-08	●	S08	VBD-BG, VBE-BG,	15
		TM-WRENCH-13-10	●	S10	VBE-BGA, VDP,	28
		TM-WRENCH-16-12	●	S12	VDS, VCA,	28
		TM-WRENCH-20-15	●	S15	VBO, VBL, VBN, HPAV06-S	40
Open wrenches for 2 flute heads		TM-WRENCH-4E-05	●	S05	VRB, VRC,	7
		TM-WRENCH-5E-06	●	S06	VFX**-02,	10
		TM-WRENCH-7E-08	●	S08	VBB-BM, VBB-BG,	15
		TM-WRENCH-8E-10	●	S10	VBB-SG, VCP,	28
		TM-WRENCH-9E-12	●	S12	VGC, VCW, VCR	28
90° adaptor for Torx bits		INSERT-TOOL-9X12MM	●	-	-	-
Torx bits sockets		BIT-SOCKET-T20-DRIVE	●	S05, S06	VFM120, VTB135, VTB160W2.00, VTB165W2.00	7, 10
		BIT-SOCKET-T25-DRIVE	●	S06	VFM160, VTB160W3.00, VTB160W4.00, VTB165W3.00, VTB165W4.00	10
		BIT-SOCKET-T30-DRIVE	●	S08	VTB195	15
		BIT-SOCKET-T40-DRIVE	●	S08, S10	VFM200, VST277, VTB225	15, 28
		BIT-SOCKET-T50-DRIVE	●	S08, S10	VFM250, VTB250	15, 28



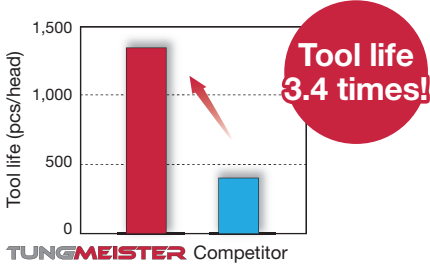
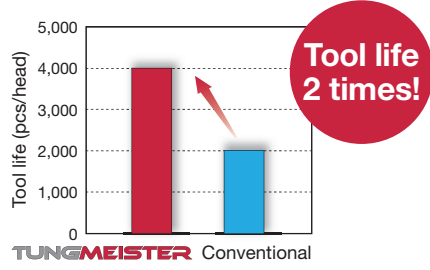



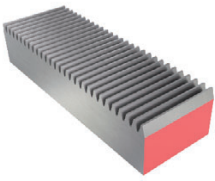

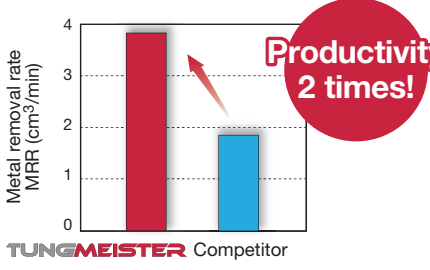
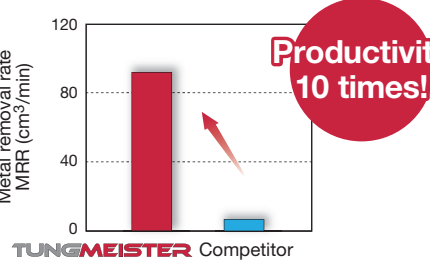

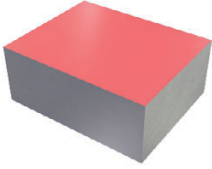
CAUTIONARY POINTS IN USE

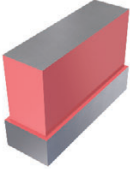
- The cutting heads specified by Tungaloy must be used. Avoid using alternate heads that are not Tungaloy products as this will damage the shank and can cause severe accident or injury.
- Before setting the head, clean the connection screw with an air blast or a wiping cloth to remove chips and other foreign matter that may remain.
- Do not apply the lubricant to the connection screw.
- Please use the correct wrench with the correct cutting head. Tighten the head slowly until the face of the head contacts the shank. (Please refer to the picture shown on the right.) Do not re-tightening or over-tightening. Excessive tightening may cause the cutting head to break.
- Do not apply excessive force or a hammer when tightening or exchanging the cutting heads.

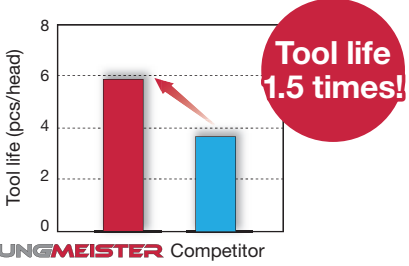
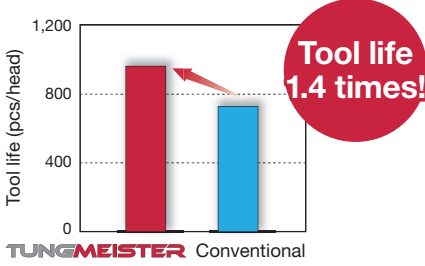

PRACTICAL EXAMPLES

Workpiece type		CVJ	Gear
Shank		VSSD12L070S08-C (Carbide, ø12 mm)	VSSD16L100S10-S (Steel, ø16 mm)
Head		VBD120L09.0-BG-04S08 (ø12 mm)	VEE160L12.0C60I04S10 (ø16 mm)
Grade		AH715 S53C	AH715 SCM420 / 18CrMo4
Workpiece material		 Ball  	 Square  
Cutting conditions	Cutting speed : V_c (m/min)	41	100
	Feed per tooth: f_z (mm/t)	0.03	0.09
	Depth of cut : a_p (mm)	-	10
	Width of cut : a_e (mm)	3	0.1
	Coolant	Wet	Wet
Results		 <p>Tool life 3.4 times!</p> <p>TUNGMEISTER Competitor</p> <p>The latest wear-resistant PVD grade, AH715 provided 3.4 times increase in tool life. With minimal flank wear, as well as less burr formation, AH715 could still have continued cutting.</p>	 <p>Tool life 2 times!</p> <p>TUNGMEISTER Conventional</p> <p>AH715, the latest PVD coating grade improved the insert's wear resistance, providing 2 times increase in tool life increase.</p>
Workpiece type		Shaft	Rack
Shank		VSSD10L075S06-S (Steel, ø10 mm)	VSSD25L075S12-S (Steel, ø25 mm)
Head		VEH100L15.0R10I04S06 (ø10 mm)	VEH200L30.0R05I04S12 (ø20 mm)
Grade		AH715 S45C / C45	AH715 SCM440 / 42CrMo4
Workpiece material		 Square  	 Square  
Cutting conditions	Cutting speed : V_c (m/min)	100	140
	Feed per tooth: f_z (mm/t)	0.05	0.08
	Depth of cut : a_p (mm)	1	24
	Width of cut : a_e (mm)	6	5.5
	Coolant	Wet	Wet
Results		 <p>Productivity 2 times!</p> <p>TUNGMEISTER Competitor</p> <p>VEH milling head enabled the applications of elevated cutting speed and feed rate thanks to its excellent anti-vibration design.</p>	 <p>Productivity 10 times!</p> <p>TUNGMEISTER Competitor</p> <p>VEH milling head enabled the use of wider cutting width (a_e), thanks to excellent anti-vibration design, reducing the number of passes for improved cycle time.</p>

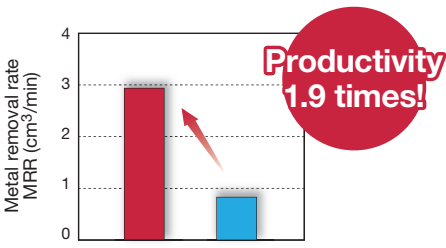
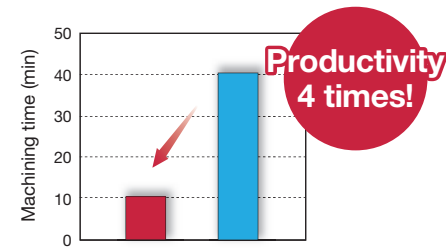
Workpiece type		Housing	Machine part
Shank		VSTD10L080S06-S (Carbide, ø10 mm)	VSSD16L130S10-C (Carbide, ø16 mm)
Head		VFM160L04.8R04I06S06 (ø16 mm)	VEH160L24.0R05I04S10 (ø16 mm)
Grade		AH715	AH715
Workpiece material		SS400 / E275A	FCD400 / GGG40
		  	  
Cutting conditions	Cutting speed : Vc (m/min)	126	100
	Feed per tooth: fz (mm/t)	0.12	0.04
	Depth of cut : ap (mm)	0.2	15
	Width of cut : ae (mm)	16	1
	Coolant	Wet	Wet
Results		 <p>With a larger cutting head diameter, VFM milling head increased radial cutting width (ae), improving cycle time with reduced number of passes.</p>	 <p>AH715, the latest PVD coating grade improved the insert's wear resistance, providing 1.4 times increase in tool life increase and better surface finish.</p>
Workpiece type		Shaft	Test piece
Shank		VER11CL020S05-S (Steel, ø8 mm)	VSSD10L090S06-C (Carbide, ø10 mm)
Head		VFM120L03.6R02I06S05 (ø12 mm)	VBO100L15.0R850-5S06 (ø10 mm)
Grade		AH715	AH715
Workpiece material		S45C / C45	S45C / C45
		  	  
Cutting conditions	Cutting speed : Vc (m/min)	60	300
	Feed per tooth: fz (mm/t)	0.05	0.02
	Depth of cut : ap (mm)	1	0.05
	Width of cut : ae (mm)	6	0.5
	Coolant	Wet	Wet
Results		 <p>VFM reduced the number of passes and vibration thanks to its larger cutting head diameter. As a result, productivity increased by 1.9 times.</p>	 <p>Thanks to barrel shape cutting edges suited for the use on 5-axis machine, VBO head provided 4 times increase in productivity over ball endmill without compromising surface quality.</p>

Tungaloy Corporation (Head office)

11-1 Yoshima-Kogyodanchi
Iwaki-city, Fukushima 970-1144 Japan
Phone: +81-246-36-8501
Fax: +81-246-36-8542
www.tungaloy.co.jp

Tungaloy America, Inc.

3726 N Ventura Drive
Arlington Heights, IL 60004, U.S.A.
Phone: +1-888-554-8394
Fax: +1-888-554-8392
www.tungaloy.com/us

Tungaloy Canada

432 Elgin St. Unit 3
Brantford, Ontario N3S 7P7, Canada
Phone: +1-519-758-5779
Fax: +1-519-758-5791
www.tungaloy.com/ca

Tungaloy de Mexico S.A.

C. Los Arellano 113,
Parque Industrial Siglo XXI
Aguascalientes, AGS, Mexico 20290
Phone: +52-449-929-5410
Fax: +52-449-929-5411
www.tungaloy.com/mx

Tungaloy do Brasil Ltda.

Avd. Independencia N4158 Residencial Flora
13280-000 Vinhedo, São Paulo, Brasil
Phone: +55-19-38262757
Fax: +55-19-38262757
www.tungaloy.com/br

Tungaloy Germany GmbH

An der Alten Ziegelei 1
D-40789 Monheim, Germany
Phone: +49-2173-90420-0
Fax: +49-2173-90420-19
www.tungaloy.com/de

Tungaloy France S.A.S.

ZA Courtaboëuf - Le Rio
1 rue de la Terre de feu
F-91952 Courtaboëuf Cedex, France
Phone: +33-1-6486-4300
Fax: +33-1-6907-7817
www.tungaloy.com/fr

Tungaloy Italia S.r.l.

Via E. Andolfato 10
I-20126 Milano, Italy
Phone: +39-02-252012-1
Fax: +39-02-252012-65
www.tungaloy.com/it

Tungaloy Czech s.r.o.

Turanka 115
CZ-627 00 Brno, Czech Republic
Phone: +420-532 123 391
Fax: +420-532 123 392
www.tungaloy.com/cz

Tungaloy Ibérica S.L.

C/Miquel Servet, 43B, Nau 7
Pol. Ind. Bufalvent
ES-08243 Manresa (BCN), Spain
Phone: +34 93 113 1360
Fax: +34 93 876 2798
www.tungaloy.com/es

Tungaloy Scandinavia AB

Bultgatan 38
442 40 Kungälv, Sweden
Phone: +46-462119200
Fax: +46-462119207
www.tungaloy.com/se

Tungaloy Rus, LLC

Andropova avenue, h.18/7,
11 floor, office 3, 115432,
Moscow, Russia
Phone: +7-499-683-01-80
Fax: +7-499-683-01-81
www.tungaloy.com/ru

Tungaloy Polska Sp. z o.o.

Ul. Irysowa 1, 55-040 Bielany
Wroclawskie, Poland
Phone: +48 607 907 237
www.tungaloy.com/pl

Tungaloy U.K. Ltd

Gallan Park, Watling Street,
Cannock, WS110XG, UK
Phone: +44 121 4000 231
Fax: +44 121 270 9694
www.tungaloy.com/uk

Tungaloy Hungary Kft

Erzsébet királyné útja 125
H-1142 Budapest, Hungary
Phone: +36 1 781-6846
Fax: +36 1 781-6866
www.tungaloy.com/hu

Tungaloy Turkey

Serifali Mah.bayraktar Bulvari Kule Sk. No:26
34775 Umraniye / Istanbul / Turkey
Phone: +90 216 540 04 67
Fax: +90 216 540 04 87
www.tungaloy.com/tr

Tungaloy Benelux b.v.

Tjalk 70
NL-2411 NZ Bodegraven, Netherlands
Phone: +31 172 630 420
Fax: +31 172 630 429
www.tungaloy.com/nl

Tungaloy Croatia

Ulica bana Josipa Jelačića 87,
10430, Samobor, Croatia
Phone: +385 1 3326 604
Fax: +385 1 3327 683
www.tungaloy.com/hr

Tungaloy Cutting Tool (Shanghai) Co.,Ltd.

Rm No 401 No.88 Zhabei
Jiangchang No.3 Rd
Shanghai 200436, China
Phone: +86-21-3632-1880
Fax: +86-21-3621-1918
www.tungaloy.com/cn

Tungaloy Cutting Tools (Taiwan) Co.,Ltd.

9F. No.293, Zhongyang Rd,
Xinzhuan Dist, New Taipei City,
24251 Taiwan
Phone: +886-2-8521-9986
Fax: +886-2-8521-8935
www.tungaloy.com/tw

Tungaloy Cutting Tools (Thailand) Co.,Ltd.

Interlink tower 4th Fl.
1858/5-7 Bangna-Trad Road
km.5 Bangna, Bangna, Bangkok 10260
Thailand
Phone: +66-2-751-5711
Fax: +66-2-751-5715
www.tungaloy.com/th

Tungaloy Singapore (Pte.), Ltd.

62 Ubi Road 1, #06-11 Oxley BizHub 2
Singapore 408734
Phone: +65-6391-1833
Fax: +65-6299-4557
www.tungaloy.com/sing

Tungaloy Vietnam

LE04.38, Lexington Residence
67 Mai Chi Tho St., Dist. 2,
Ho Chi Minh City, Vietnam
Phone: +84-2837406660
www.tungaloy.com/sing

Tungaloy India Pvt. Ltd.

One International Center,
Unit # 902-A, 9th Floor,
Tower 1, Senapati Bapat Marg,
Elphinstone Road (West),
Mumbai-400013, India
Phone: +91-22-6124-8804
Fax: +91-22-6124-8899
www.tungaloy.com/in

Tungaloy Korea Co., Ltd

#1312, Byucksan Digital Valley 5-cha
Beotkkot-ro 244, Geumcheon-gu
153-788 Seoul, Korea
Phone: +82-2-2621-6161
Fax: +82-2-6393-8952
www.tungaloy.com/kr

Tungaloy Malaysia Sdn Bhd

50 K-2, Kelana Mall, Jalan SS6/14
Kelana Jaya, 47301
Petaling Jaya, Selangor Darul Ehsan
Malaysia
Phone: +603-7805-3222
Fax: +603-7804-8563
www.tungaloy.com/my

Tungaloy Australia Pty Ltd

Unit 68 1470 Ferntree Gully Road
Knoxfield 3180 Victoria, Australia
Phone: +61-3-9755-8147
Fax: +61-3-9755-6070
www.tungaloy.com/au

PT. Tungaloy Indonesia

Kompleks Grand Wisata Block AA-10 No.3-5
Cibitung
Bekasi 17510, Indonesia
Phone: +62-21-8261-5808
Fax: +62-21-8261-5809
www.tungaloy.com/id



www.tungaloy.com

follow us at:

facebook.com/tungaloyjapan

twitter.com/tungaloyjapan

www.youtube.com/tungaloycorporation

Distributed by:



 FIND US ON THE CLOUD!
machiningcloud.com



AS9100 Certified
78006
2015.11.04
ISO14001 Certified
EC97J1123
1997.11.26