

Internal grooving tool

**ADD**INTERNAL  
**CUT**

Tungaloy Report No. 544-G

# New 4-edged insert for ID grooving

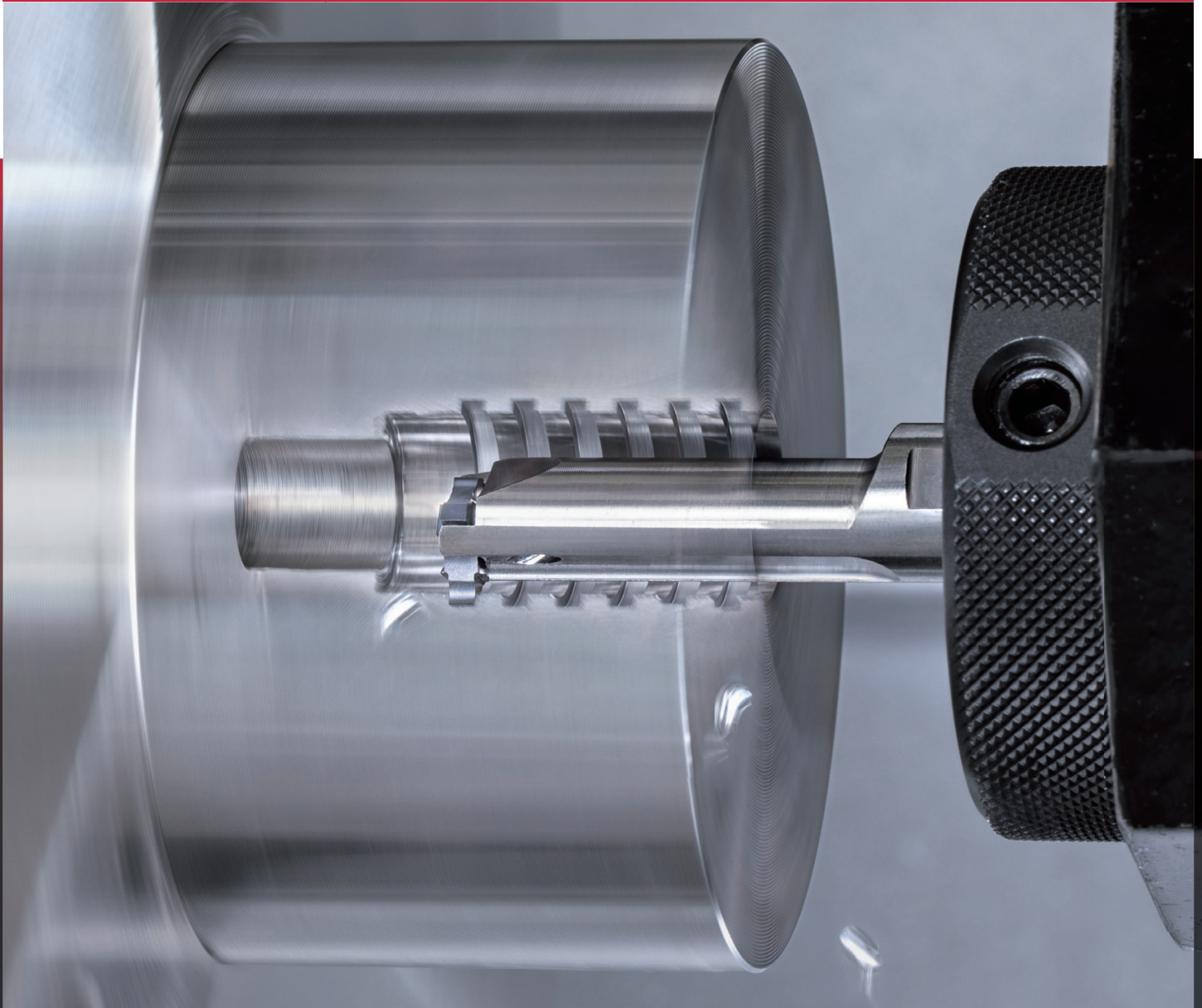

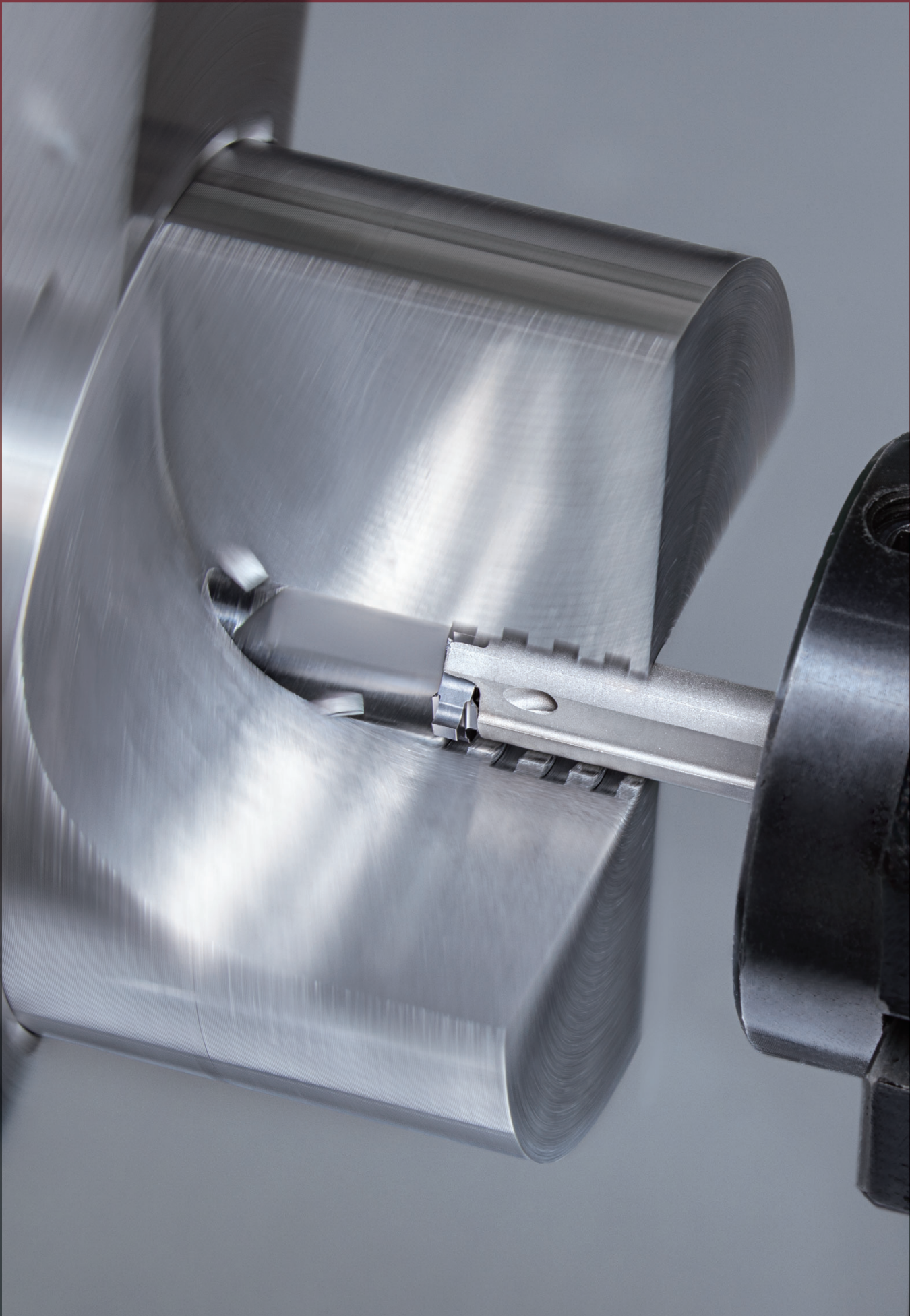

**INDUSTRY 4.0**  
*FEED the SPEED!*



## ADD<sup>INTERNAL</sup>CUT

---

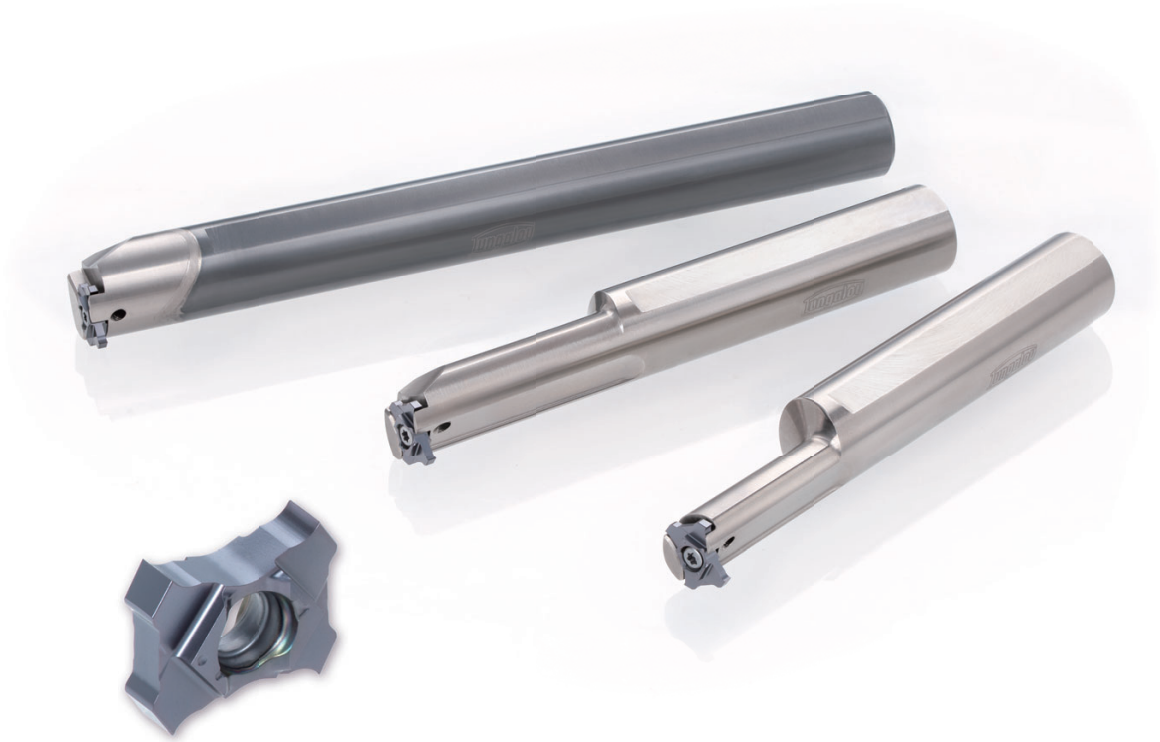

Unique insert clamping system ensures high indexing repeatability and clamping rigidity

## Unique clamping system for high precision grooving

### Features

- 1** The insert is supported at three optimized positions for rigid clamping and superior repeatability

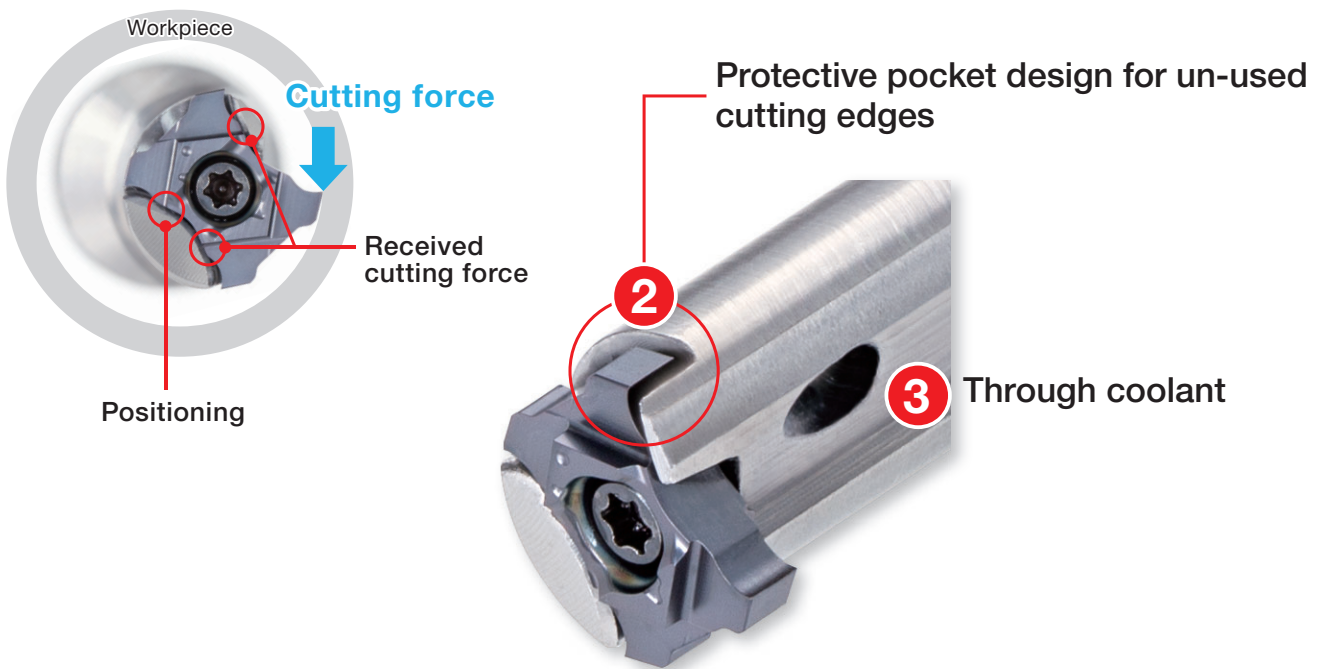

- 4** The same insert can be assembled on either left- or right-handed holder

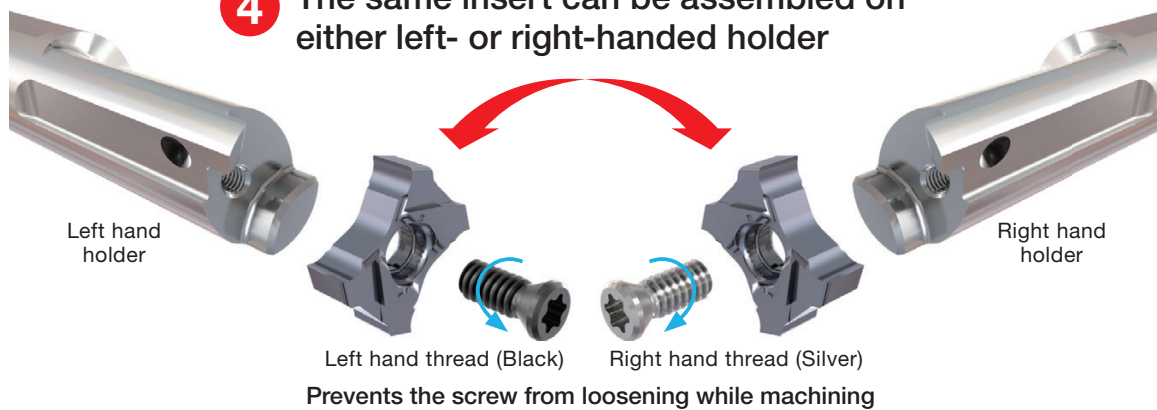

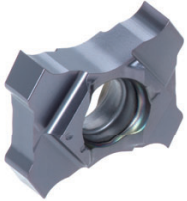

Free cutting geometry for superior surface finish  
 CW = 1.5 - 2.5 mm

TCIG...

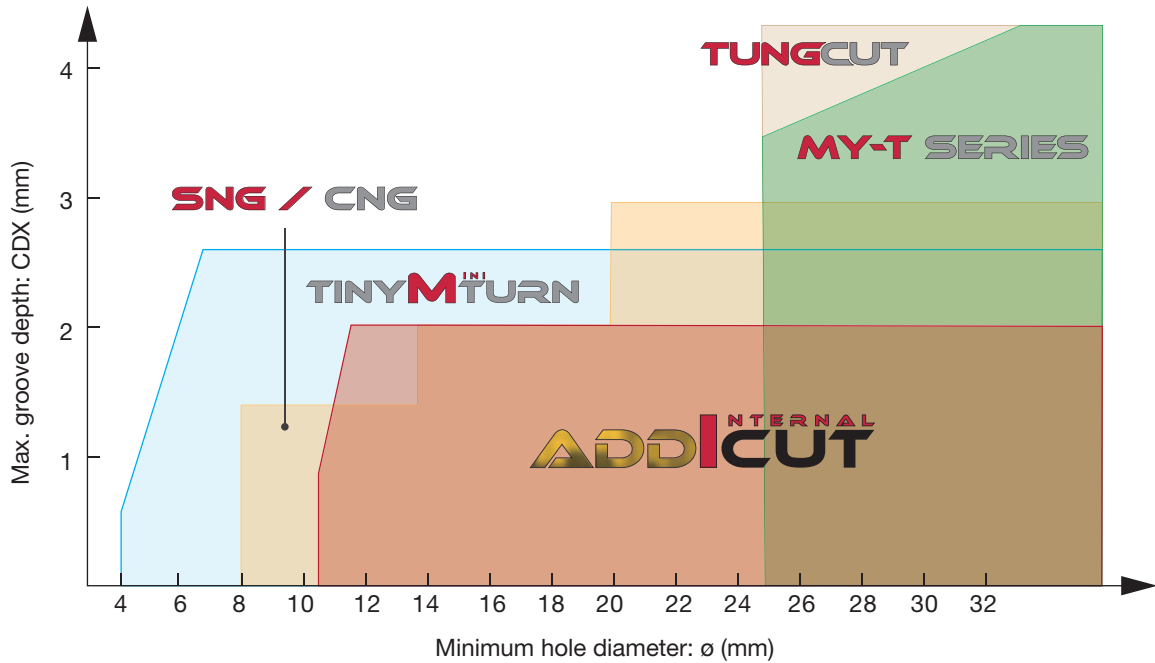

## CUTTING PERFORMANCE

### Chip control

Cutting speed: $V_c$ (m/min)	120			
	100			
	80			
		0.05	0.08	0.1
		Feed: $f$ (mm/rev)		

Toolholder : A12H-STCIR10-D120  
 Insert : TCIG10-200-010 AH725  
 Workpiece material : S45C / C45  
 Groove width : CW = 2 mm  
 Hole diameter : ø12 mm  
 Coolant : Wet

## HOLDER

### A/E-STCIR/L

Internal grooving toolholder

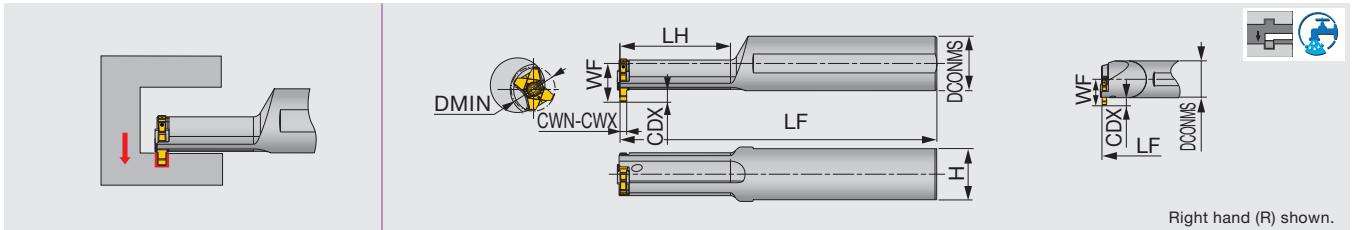

Right hand (R) shown.

Designation	Material	CWN	CWX	Seat size	DMIN	DCONMS	LH	LF	WF	H	Insert	Torque*
A12H-STCIR/L10-D105	Steel	1.5	2.5	10	10.5	12	24	100	8.3	11	TCIG10...	1
A12H-STCIR/L10-D120	Steel	1.5	2.5	10	12	12	30	100	8.3	11	TCIG10...	1
E12K-STCIR/L10-D150	Carbide	1.5	2.5	10	15	12	-	125	8.3	11	TCIG10...	1

\*Torque: Recommended clamping torque (N-m)

### SPARE PARTS



Designation	Clamping screw
A/E-STCIR10-...	CSTB-2.2L053DR
A/E-STCIL10-...	CSTB-2.2L053DL

## INSERTS

### TCIG

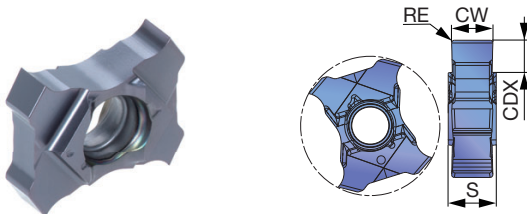

<b>P</b>	Steel	★							
<b>M</b>	Stainless	★							
<b>K</b>	Cast iron	★							
<b>N</b>	Non-ferrous								
<b>S</b>	Superalloys	★							
<b>H</b>	Hard materials								

Designation	CW±0.025	RE	Coated						CDX	S
			AH725							
TCIG10-150-010	1.5	0.1	●						2	3.5
TCIG10-200-010	2	0.1	●						2	3.5
TCIG10-250-020	2.5	0.2	●						2	3.5

Note: Max groove depth for small holes

For hole diameters less than 11.5 mm, the maximum groove depth (T max) for the insert becomes smaller than the specified value. Check the actual value in the chart below for hole diameters < 11.5 mm.

● : Line up

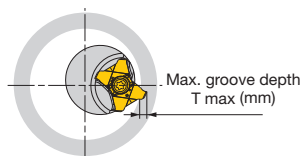
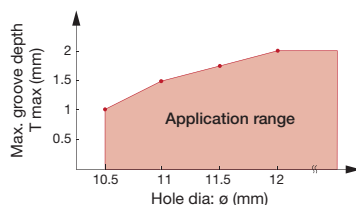

## STANDARD CUTTING CONDITIONS

ISO	Workpiece material	Hardness	Priority	Cutting speed Vc (m/min)	Feed f (mm/rev)
<b>P</b>	Steels S45C, C45, SCM435, 34CrMo4, etc.	< 300 HB	First choice	50 - 180	0.02 - 0.08
<b>M</b>	Stainless steel SUS303, X10CrNiS18-9, etc.	< 200 HB	First choice	50 - 120	0.02 - 0.08
<b>S</b>	Titanium alloys Ti-6Al-4V, etc.	< HRC 40	First choice	20 - 80	0.02 - 0.08

## PRACTICAL EXAMPLES

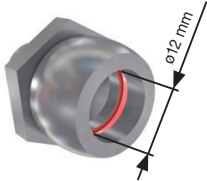
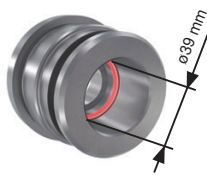
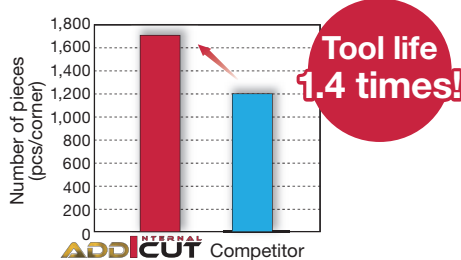
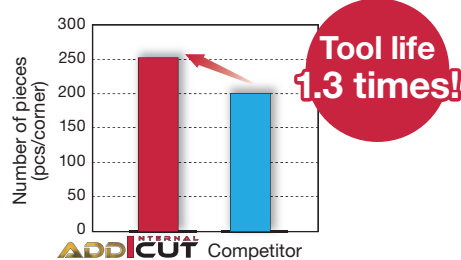
Workpiece type		Adapter	Cylinder Head	
Toolholder		A12H-STCIR10-D105	A12H-STCIR10-D120	
Insert		TCIG10-200-010	TCIG10-200-010	
Grade		AH725	AH725	
Workpiece material		SUM23 (Free alloy steel)	S45C /C45	
		 <b>P</b>	 <b>P</b>	
Cutting conditions	Grooving width (mm)	2	2	
	Grooving depth (mm)	1	1.15	
	Cutting speed : Vc (m/min)	50	90	
	Feed : f (mm/rev)	0.05	0.05	
	Machining	Internal grooving	Internal grooving	
	Coolant	Wet	Wet	
Results	 <p><b>Tool life 1.4 times!</b></p> <p>AddInternalCut provided part quality consistency thanks to secure insert clamping and also provided 1.4 times tool life increase.</p>		 <p><b>Tool life 1.3 times!</b></p> <p>AddInternalCut provided 1.3 times tool life and excellent surface finish due to highly rigid insert clamping.</p>	

## Tungaloy Corporation (Head office)

11-1 Yoshima-Kogyodanchi  
Iwaki-city, Fukushima 970-1144 Japan  
Phone: +81-246-36-8501  
Fax: +81-246-36-8542  
www.tungaloy.co.jp

## Tungaloy America, Inc.

3726 N Ventura Drive  
Arlington Heights, IL 60004, U.S.A.  
Phone: +1-888-554-8394  
Fax: +1-888-554-8392  
www.tungaloy.com/us

## Tungaloy Canada

432 Elgin St. Unit 3  
Brantford, Ontario N3S 7P7, Canada  
Phone: +1-519-758-5779  
Fax: +1-519-758-5791  
www.tungaloy.com/ca

## Tungaloy de Mexico S.A.

C. Los Arellano 113,  
Parque Industrial Siglo XXI  
Aguascalientes, AGS, Mexico 20290  
Phone: +52-449-929-5410  
Fax: +52-449-929-5411  
www.tungaloy.com/mx

## Tungaloy do Brasil Ltda.

Avd. Independencia N4158 Residencial Flora  
13280-000 Vinhedo, São Paulo, Brasil  
Phone: +55-19-38262757  
Fax: +55-19-38262757  
www.tungaloy.com/br

## Tungaloy Germany GmbH

An der Alten Ziegelei 1  
D-40789 Monheim, Germany  
Phone: +49-2173-90420-0  
Fax: +49-2173-90420-19  
www.tungaloy.com/de

## Tungaloy France S.A.S.

ZA Courtaboeuf - Le Rio  
1 rue de la Terre de feu  
F-91952 Courtaboeuf Cedex, France  
Phone: +33-1-6486-4300  
Fax: +33-1-6907-7817  
www.tungaloy.com/fr

## Tungaloy Italia S.r.l.

Via E. Andolfato 10  
I-20126 Milano, Italy  
Phone: +39-02-252012-1  
Fax: +39-02-252012-65  
www.tungaloy.com/it

## Tungaloy Czech s.r.o.

Turanka 115  
CZ-627 00 Brno, Czech Republic  
Phone: +420-532 123 391  
Fax: +420-532 123 392  
www.tungaloy.com/cz

## Tungaloy Ibérica S.L.

C/Miquel Servet, 43B, Nau 7  
Pol. Ind. Bufalvent  
ES-08243 Manresa (BCN), Spain  
Phone: +34 93 113 1360  
Fax: +34 93 876 2798  
www.tungaloy.com/es

## Tungaloy Scandinavia AB

Bultgatan 38  
442 40 Kungälv, Sweden  
Phone: +46-462119200  
Fax: +46-462119207  
www.tungaloy.com/se

## Tungaloy Rus, LLC

Andropova avenue, h.18/7,  
11 floor, office 3, 115432,  
Moscow, Russia  
Phone: +7-499-683-01-80  
Fax: +7-499-683-01-81  
www.tungaloy.com/ru

## Tungaloy Polska Sp. z o.o.

Ul. Irysowa 1, 55-040 Bielany  
Wroclawskie, Poland  
Phone: +48 607 907 237  
www.tungaloy.com/pl

## Tungaloy U.K. Ltd

Gallan Park, Watling Street,  
Cannock, WS110XG, UK  
Phone: +44 121 4000 231  
Fax: +44 121 270 9694  
www.tungaloy.com/uk

## Tungaloy Hungary Kft

Erzsébet királyné útja 125  
H-1142 Budapest, Hungary  
Phone: +36 1 781-6846  
Fax: +36 1 781-6866  
www.tungaloy.com/hu

## Tungaloy Turkey

Serifali Mah.bayraktar Bulvari Kule Sk. No:26  
34775 Umraniye / Istanbul / Turkey  
Phone: +90 216 540 04 67  
Fax: +90 216 540 04 87  
www.tungaloy.com/tr

## Tungaloy Benelux b.v.

Tjalk 70  
NL-2411 NZ Bodegraven, Netherlands  
Phone: +31 172 630 420  
Fax: +31 172 630 429  
www.tungaloy.com/nl

## Tungaloy Croatia

Ulica bana Josipa Jelačića 87,  
10430, Samobor, Croatia  
Phone: +385 1 3326 604  
Fax: +385 1 3327 683  
www.tungaloy.com/hr

## Tungaloy Cutting Tool (Shanghai) Co.,Ltd.

Rm No 401 No.88 Zhabei  
Jiangchang No.3 Rd  
Shanghai 200436, China  
Phone: +86-21-3632-1880  
Fax: +86-21-3621-1918  
www.tungaloy.com/cn

## Tungaloy Cutting Tools (Taiwan) Co.,Ltd.

9F, No.293, Zhongyang Rd,  
Xinzhuan Dist, New Taipei City,  
24251 Taiwan  
Phone: +886-2-8521-9986  
Fax: +886-2-8521-8935  
www.tungaloy.com/tw

## Tungaloy Cutting Tools (Thailand) Co.,Ltd.

Interlink tower 4th Fl.  
1858/5-7 Bangna-Trad Road  
km.5 Bangna, Bangna, Bangkok 10260  
Thailand  
Phone: +66-2-751-5711  
Fax: +66-2-751-5715  
www.tungaloy.com/th

## Tungaloy Singapore (Pte.), Ltd.

62 Ubi Road 1, #06-11 Oxley BizHub 2  
Singapore 408734  
Phone: +65-6391-1833  
Fax: +65-6299-4557  
www.tungaloy.com/sing

## Tungaloy Vietnam

LE04.38, Lexington Residence  
67 Mai Chi Tho St., Dist. 2,  
Ho Chi Minh City, Vietnam  
Phone: +84-2837406660  
www.tungaloy.com/sing

## Tungaloy India Pvt. Ltd.

Indiabulls Finance Centre,  
Unit # 902-A, 9th Floor,  
Tower 1, Senapati Bapat Marg,  
Elphinstone Road (West),  
Mumbai -400013, India  
Phone: +91-22-6124-8804  
Fax: +91-22-6124-8899  
www.tungaloy.com/in

## Tungaloy Korea Co., Ltd

#1312, Byucksan Digital Valley 5-cha  
Beotkkot-ro 244, Geumcheon-gu  
153-788 Seoul, Korea  
Phone: +82-2-2621-6161  
Fax: +82-2-6393-8952  
www.tungaloy.com/kr

## Tungaloy Malaysia Sdn Bhd

50 K-2, Kelana Mall, Jalan SS6/14  
Kelana Jaya, 47301  
Petaling Jaya, Selangor Darul Ehsan  
Malaysia  
Phone: +603-7805-3222  
Fax: +603-7804-8563  
www.tungaloy.com/my

## Tungaloy Australia Pty Ltd

Unit 68 1470 Ferntree Gully Road  
Knoxfield 3180 Victoria, Australia  
Phone: +61-3-9755-8147  
Fax: +61-3-9755-6070  
www.tungaloy.com/au

## PT. Tungaloy Indonesia

Kompleks Grand Wisata Block AA-10 No.3-5  
Cibitung  
Bekasi 17510, Indonesia  
Phone: +62-21-8261-5808  
Fax: +62-21-8261-5809  
www.tungaloy.com/id



www.tungaloy.com

follow us at:

facebook.com/tungaloyjapan  
twitter.com/tungaloyjapan  
www.youtube.com/tungaloycorporation



AS9100 Certified  
78006  
2015.11.04  
ISO 14001 Certified  
EC97J1123  
1997.11.26

Distributed by:



FIND US ON THE CLOUD!  
machiningcloud.com

