

Exchangeable head turning tool system for Swiss machines

MODUM^{INI}TURN

Tungaloy Report No. 541S1-G

New Y-axis exchangeable heads for optimal cutting and chip evacuation

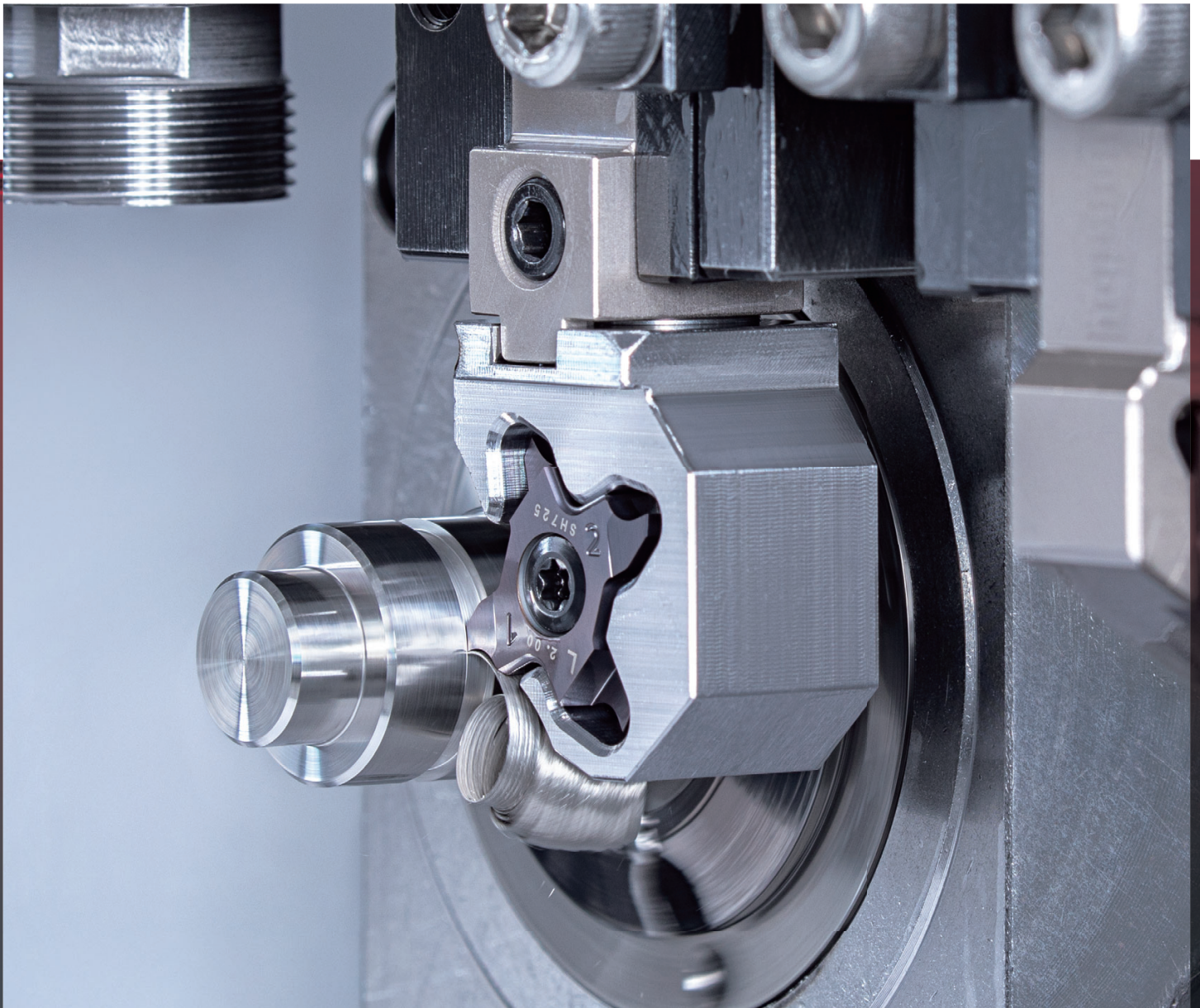



Exchangeable head turning tool system for Swiss machines

- ModuMini-Turn now includes Y-axis cutting heads
- Chip entanglements can permanently be eliminated by feeding the tool in the Y-axis direction

What is Y-axis feed

A machining method that moves the gang slide in the Y-axis direction, instead of traditional X-axis direction

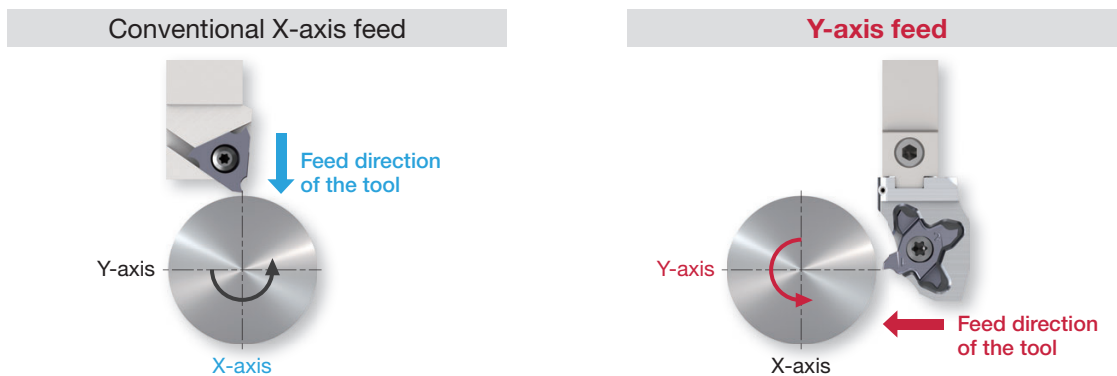

Benefits of Y-axis feed

- 1 No chip entanglements — Chips are directed downward and away from the cutting zone



- 2 High part precision and quality — The cutting tool absorbs the cutting force in the strongest, longitudinal direction of the cutting tool, providing tool stability

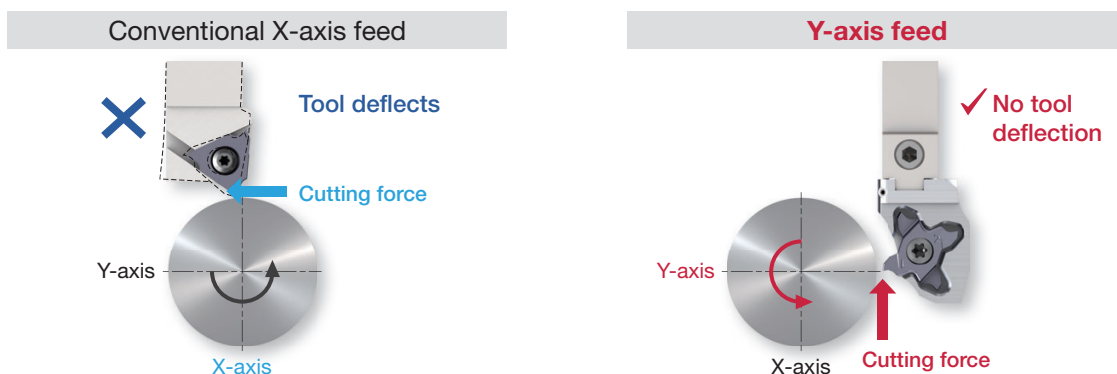

ModuMini-Turn features

- The cutting heads can be swapped while the holder remains in the gang slide
- Easy handling for reduced downtime
- Y-axis cutting heads and X-axis cutting heads are easily interchangeable

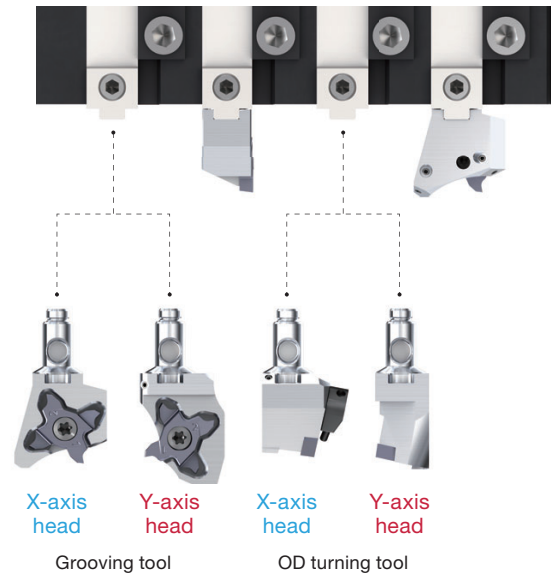

Y-axis cutting head features

- 1 Various types of cutting heads with high-pressure through-coolant capability are available



All cutting heads are available with high pressure through-coolant supply

- 2 Compact cutting head design enables side-by-side locations of Y-axis cutting heads

- No tool slots on the gang slide are unusable thanks to the slim head design

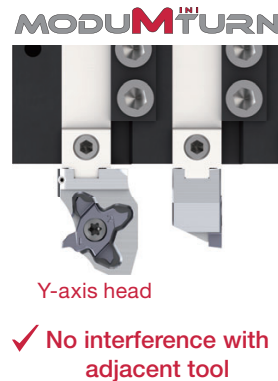
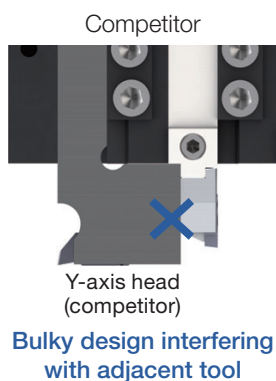

- A pair of Y-axis heads can be located side by side on the slide

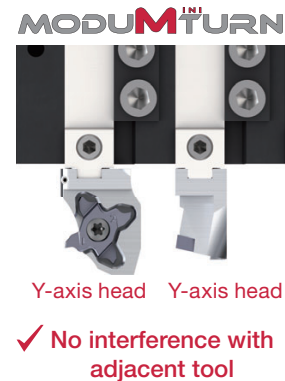

MODULAR HEADS

QC12-JSCL2CR-Y

J-SERIES

Screw-on Y-axis turning modular head with 95° approach angle, for positive 80° rhombic inserts

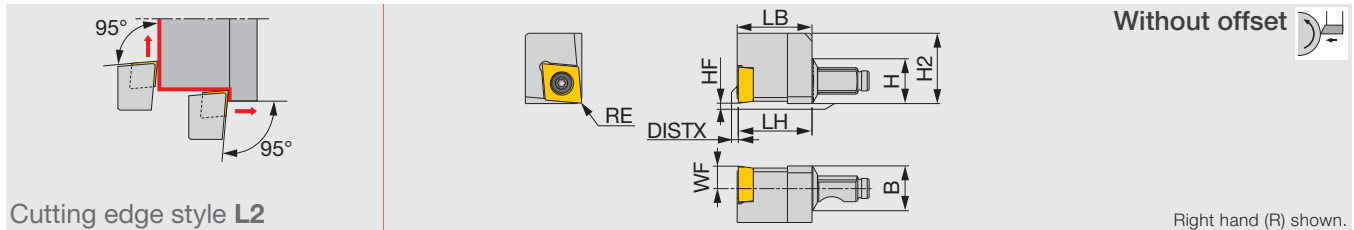

Designation	H	B	LH	HF	WF	LB	H2	DISTX	RE**	Insert	Torque*
QC12-JSCL2CR09-Y	12	12	19.5	0	6	19.8	18.6	0.3	0.2	CC**09T3...	1.2

*Torque: Recommended clamping torque (N-m)
**RE: Standard corner radius

SPARE PARTS

Designation	Clamping screw	Wrench
QC12-JSCL2CR09-Y	CSTB-4SD	T-8F

QC12-JSCL2CR-Y-CHP

J-SERIES

Screw-on Y-axis turning modular head with 95° approach angle, for positive 80° rhombic inserts, with high pressure coolant capability

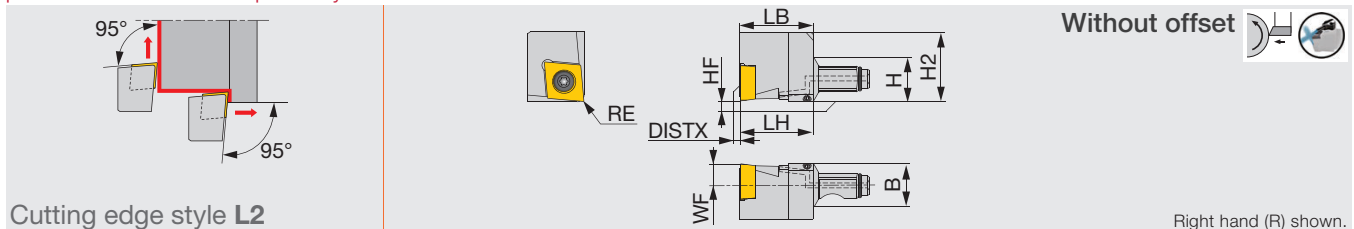

Designation	H	B	LH	HF	WF	LB	H2	DISTX	RE**	Insert	Torque*
QC12-JSCL2CR09-Y-CHP	12	12	19.5	0	6	19.8	18.6	0.3	0.2	CC**09T3...	1.2

Through-coolant head
*Torque: Recommended clamping torque (N-m)
**RE: Standard corner radius

SPARE PARTS

Designation	Clamping screw	Wrench	O-ring
QC12-JSCL2CR09-Y-CHP	CSTB-4SD	T-8F	ORSS-0454.5X1.0NBR70

QC12-JSDJ2CR-Y

J-SERIES

Screw-on Y-axis turning modular head with 93° approach angle, for positive 55° rhombic inserts

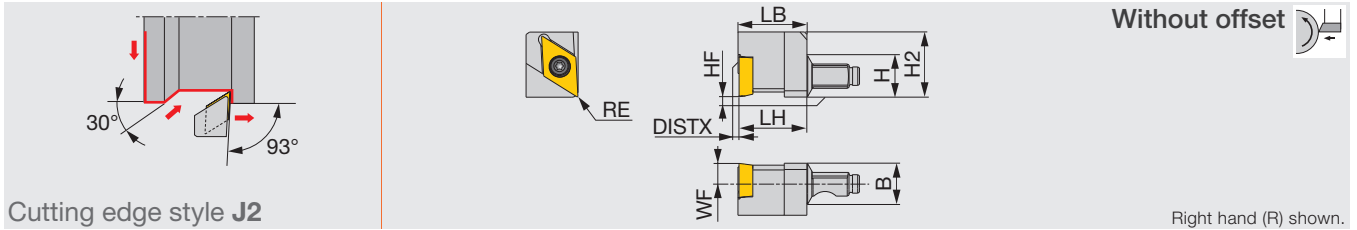

Designation	H	B	LH	HF	WF	LB	H2	DISTX	RE**	Insert	Torque*
QC12-JSDJ2CR11-Y	12	12	19.5	0	6	19.8	18.7	0.3	0.2	DC**11T3...	1.2

*Torque: Recommended clamping torque (N·m)
**RE: Standard corner radius

SPARE PARTS

Designation	Clamping screw	Wrench
QC12-JSDJ2CR11-Y	CSTB-4SD	T-8F

QC12-JSDJ2CR-Y-CHP

J-SERIES

Screw-on Y-axis turning modular head with 93° approach angle, for positive 55° rhombic inserts, with high pressure coolant capability

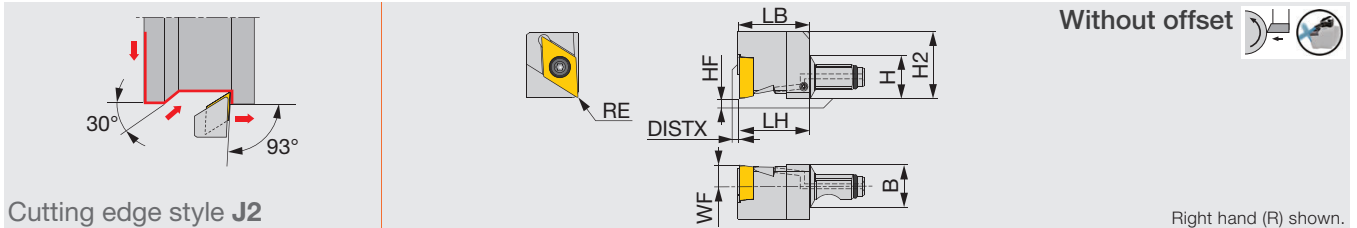

Designation	H	B	LH	HF	WF	LB	H2	DISTX	RE**	Insert	Torque*
QC12-JSDJ2CR11-Y-CHP	12	12	19.5	0	6	19.8	18.7	0.3	0.2	DC**11T3...	1.2

Through-coolant head
*Torque: Recommended clamping torque (N·m)
**RE: Standard corner radius

SPARE PARTS

Designation	Clamping screw	Wrench	O-ring
QC12-JSDJ2CR11-Y-CHP	CSTB-4SD	T-8F	ORSS-0454.5X1.0NBR70

QC12-JSWL2XR-Y

Screw-on Y-axis turning modular head with 95° approach angle, for WXGU inserts

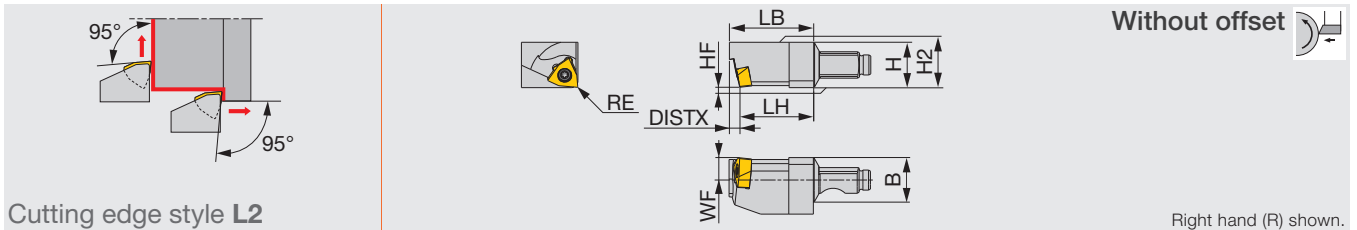

Designation	H	B	LH	HF	WF	LB	H2	DISTX	RE**	Insert	Torque*
QC12-JSWL2XR04-Y	12	12	19.5	0	6	22.3	12	2.8	0.2	WXGU0403*L...	0.9

Use right-hand toolholders (R) with left-hand inserts (L).

*Torque: Recommended clamping torque (N-m)

**RE: Standard corner radius

SPARE PARTS

Designation	Clamping screw	Wrench
QC12-JSWL2XR04-Y	SR34-514	T-7F

QC12-JSWL2XR-Y-CHP

Screw-on Y-axis turning modular head with 95° approach angle, for WXGU inserts, with high pressure coolant capability

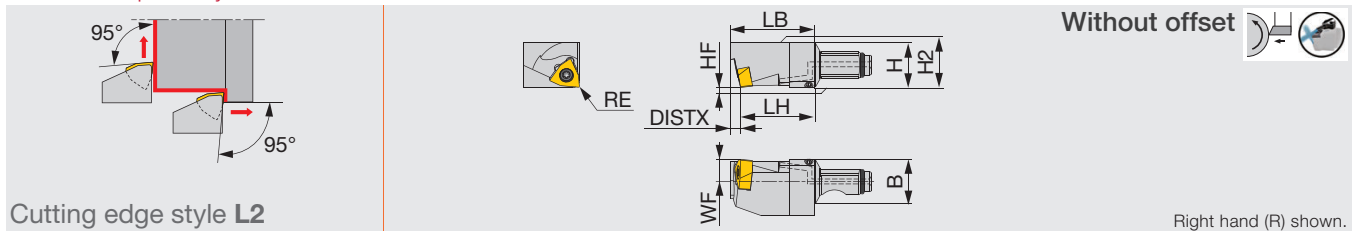

Designation	H	B	LH	HF	WF	LB	H2	DISTX	RE**	Insert	Torque*
QC12-JSWL2XR04-Y-CHP	12	12	19.5	0	6	22.3	12	2.8	0.2	WXGU0403*L...	0.9

Use right-hand toolholders (R) with left-hand inserts (L).

Through-coolant head

*Torque: Recommended clamping torque (N-m)

**RE: Standard corner radius

SPARE PARTS

Designation	Clamping screw	Wrench	O-ring
QC12-JSWL2XR04-Y-CHP	SR34-514	T-7F	ORSS-0454.5X1.0NBR70

QC12-JSDJ2XR-Y

Screw-on Y-axis turning modular head with 93° approach angle, for DX*U inserts

MINIFURN

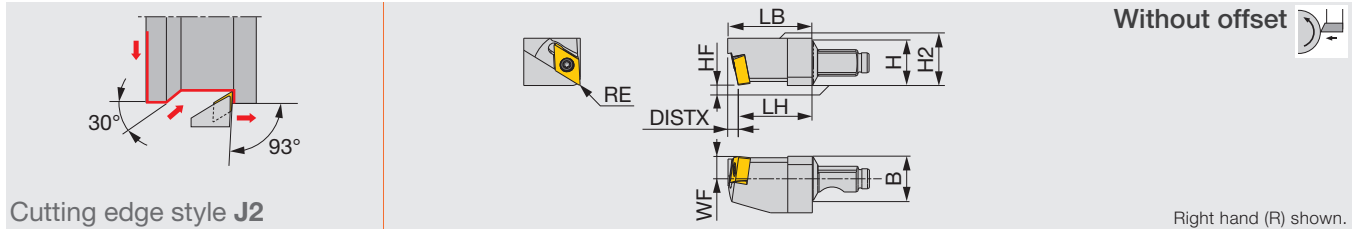

Designation	H	B	LH	HF	WF	LB	H2	DISTX	RE**	Insert	Torque*
QC12-JSDJ2XR07-Y	12	12	19.5	0	6	22.3	12.5	2.8	0.2	DX*U0703**L...	0.9

Use right-hand toolholders (R) with left-hand inserts (L).

*Torque: Recommended clamping torque (N-m)

**RE: Standard corner radius

SPARE PARTS

Designation	Clamping screw	Wrench
QC12-JSDJ2XR07-Y	SR34-514	T-7F

QC12-JSDJ2XR-Y-CHP

Screw-on Y-axis turning modular head with 93° approach angle, for DX*U inserts, with high pressure coolant capability

MINIFURN

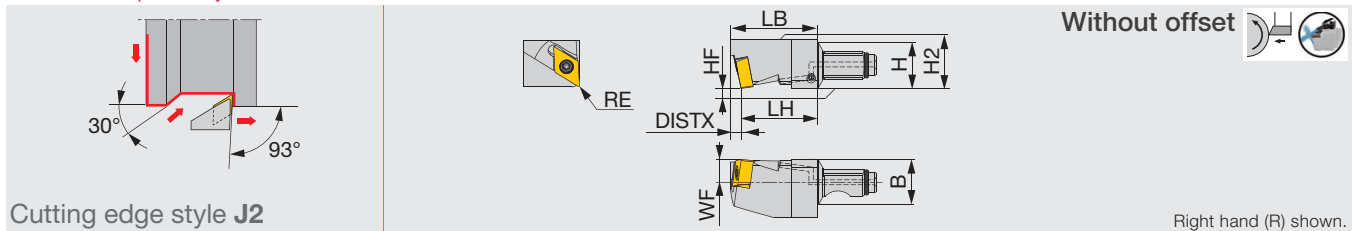

Designation	H	B	LH	HF	WF	LB	H2	DISTX	RE**	Insert	Torque*
QC12-JSDJ2XR07-Y-CHP	12	12	19.5	0	6	22.3	12.5	2.8	0.2	DX*U0703**L...	0.9

Use right-hand toolholders (R) with left-hand inserts (L).

Through-coolant head

*Torque: Recommended clamping torque (N-m)

**RE: Standard corner radius

SPARE PARTS

Designation	Clamping screw	Wrench	O-ring
QC12-JSDJ2XR07-Y-CHP	SR34-514	T-7F	ORSS-0454.5X1.0NBR70

QC12-STCR-Y

Y-axis turning modular head for external grooving and threading

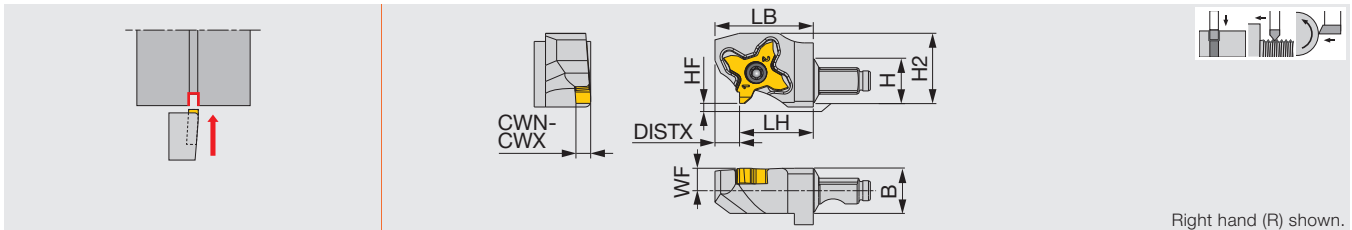

Designation	CWN	CWX	H	B	LH	HF	WF	LB	H2	DISTX	Insert	Torque*
QC12-STCR18-Y	0.33	3	12	12	19.5	0	6	26	18.6	6.5	TC*18R...	1.2

The right hand insert (R) is used for the right hand toolholder (R).
*Torque: Recommended clamping torque (N-m)

SPARE PARTS

Designation	Clamping screw	Wrench
QC12-STCR18-Y	CSTC-4L100DL	T-1008/5

Right-hand insert



TC*18R...

QC12-STCR-Y-CHP

Y-axis turning modular head for external grooving and threading, with high pressure coolant capability

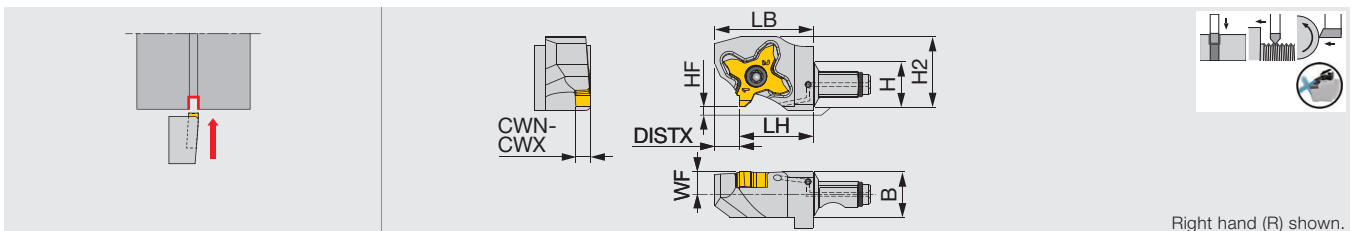

Designation	CWN	CWX	H	B	LH	HF	WF	LB	H2	DISTX	Insert	Torque*
QC12-STCR18-Y-CHP	0.33	3	12	12	19.5	0	6	26	18.6	6.5	TC*18R...	1.2

The right hand insert (R) is used for the right hand toolholder (R).
Through-coolant head
*Torque: Recommended clamping torque (N-m)

SPARE PARTS

Designation	Clamping screw	Wrench	O-ring
QC12-STCR18-Y-CHP	CSTC-4L100DL	T-1008/5	ORSS-0454.5X1.0NBR70

Right-hand insert



TC*18R...

QC12-STCL-Y

Y-axis turning modular head for external grooving and threading

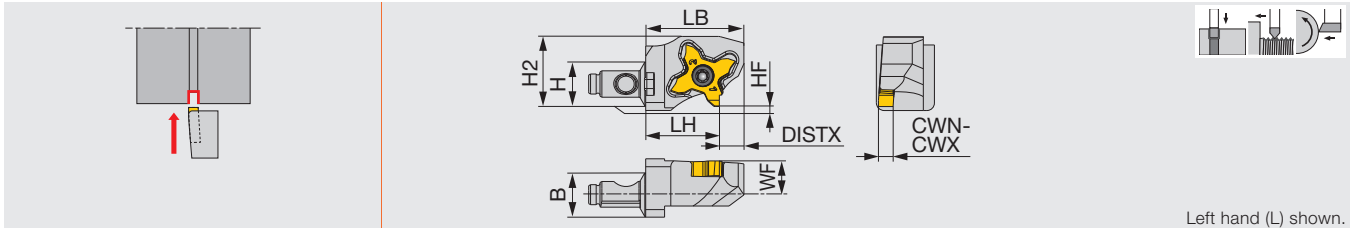

Designation	CWN	CWX	H	B	LH	HF	WF	LB	H2	DISTX	Insert	Torque*
QC12-STCL18-Y	0.33	3	12	12	19.5	0	9	26	18.6	6.5	TC*18L...	1.2

The left hand insert (L) is used for the left hand toolholder (L).
*Torque: Recommended clamping torque (N-m)

SPARE PARTS

Designation	Clamping screw	Wrench
QC12-STCL18-Y	CSTC-4L100DR	T-1008/5

Left-hand insert



TC*18L...

QC12-STCL-Y-CHP

Y-axis turning modular head for external grooving and threading, with high pressure coolant capability

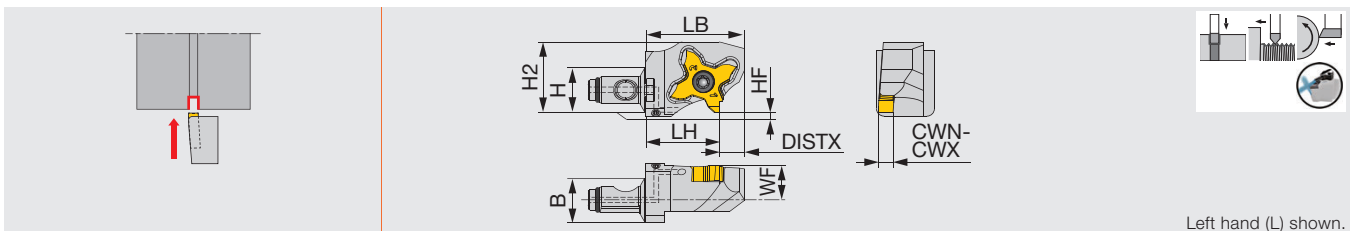

Designation	CWN	CWX	H	B	LH	HF	WF	LB	H2	DISTX	Insert	Torque*
QC12-STCL18-Y-CHP	0.33	3	12	12	19.5	0	9	26	18.6	6.5	TC*18L...	1.2

The left hand insert (L) is used for the left hand toolholder (L).
Through-coolant head
*Torque: Recommended clamping torque (N-m)

SPARE PARTS

Designation	Clamping screw	Wrench	O-ring
QC12-STCL18-CHP	CSTC-4L100DR	T-1008/5	ORSS-0454.5X1.0NBR70

Left-hand insert



TC*18L...

QC12-STOPPER

Protective plug for shank

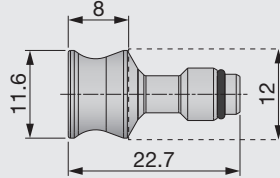

Designation

QC12-STOPPER

SPARE PARTS



Designation	O-ring
QC12-STOPPER	ORSS-0454.5X1.0NBR70



The cutting head located in the feed direction of the Y-axis tool can be removed to make room for machining larger-sized barstock. If this is the case, attach the plug to the shank to protect the coupling surface from chips, as well as prevent coolant leakage during machining.

SHANKS

QC-1212

Shank for modular heads

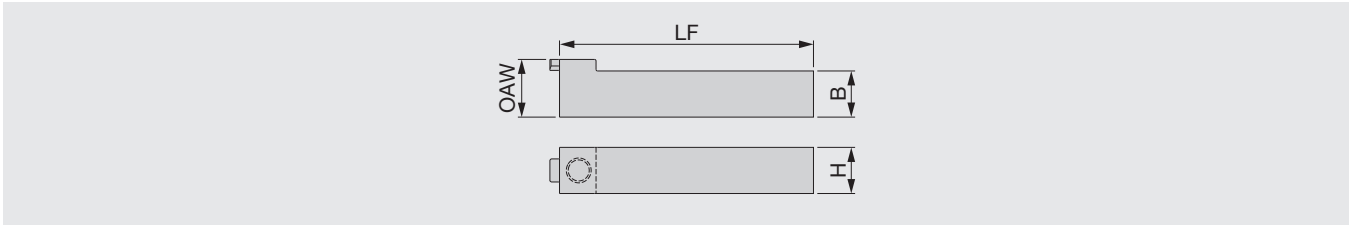

Designation	H	B	LF	OAW	Torque*
QC-1212F	12	12	65	15	3
QC-1212X	12	12	100	15	3

*Torque: Recommended clamping torque (N-m)

SPARE PARTS

Designation	Clamping screw	Wrench
QC-1212*	SRM6X0.5-26977	P-3

QC-1212-CHP

Shank for modular heads, with high pressure coolant capability

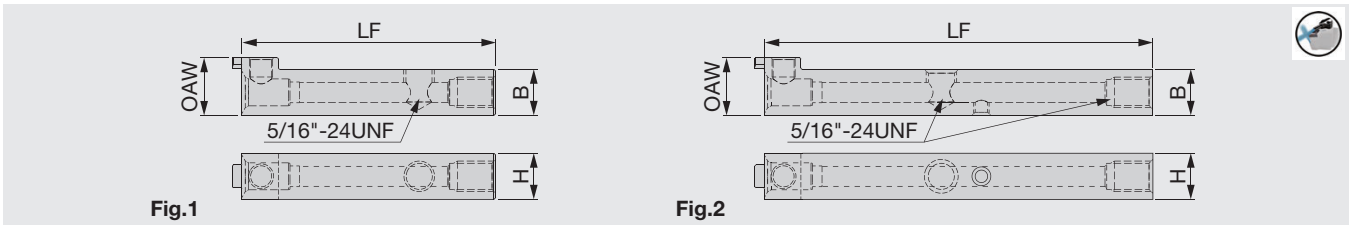

Designation	H	B	LF	OAW	Torque*	Fig.
QC-1212F-CHP	12	12	65	15	3	1
QC-1212X-CHP ⁽¹⁾	12	12	100	15	3	2

(1) Compatible to the direct internal coolant supply system without the use of external coolant hose. Through-coolant shank

*Torque: Recommended clamping torque (N-m)

SPARE PARTS

Designation	Clamping screw	Wrench	Coolant plug	Wrench	DirectJet plug	Wrench
QC-1212F-CHP	SRM6X0.5-26977	P-3	SR5/16UNFTL360	P-4	-	-
QC-1212X-CHP	SRM6X0.5-26977	P-3	SR5/16UNFTL360	P-4	SSHM4-6-TB	P-2

Cautions when using Y-axis cutting heads

Machining procedures

Conventional X-axis machining

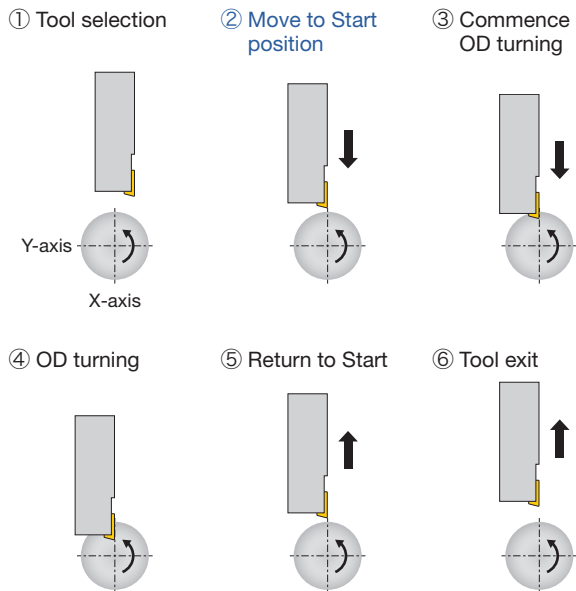

Programming sample

- ① T0200 Tool selection
- ② G00 X13.0 Z0 T2 Move to start position
- ③ G01 X10.0 F0.1 Commence OD turning
- ④ Z5.0 F0.05 OD turning
- ⑤ X13.0 Return to start position
- ⑥ G00X20.0 Tool exit

Y-axis machining

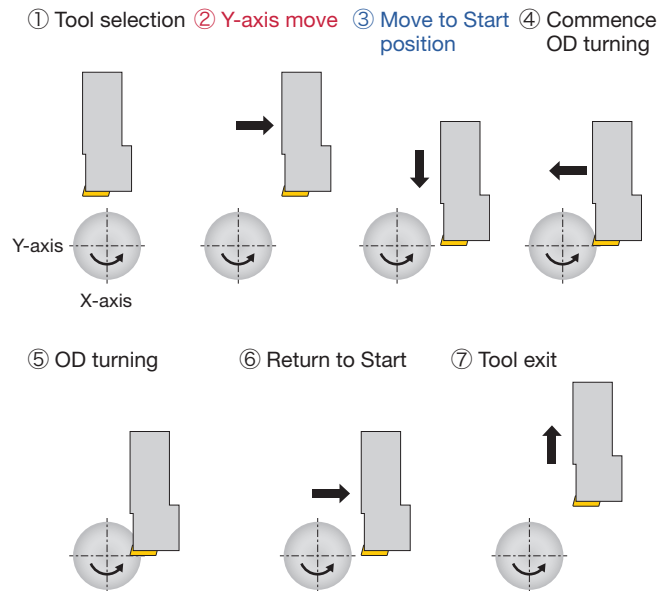

Programming sample

- ① T0200 Tool selection
- ② G00 Y13.0 Z0 T2 Move the Y-axis
- ③ X0 Move to start position
- ④ G01 Y10.0 F0.1 Commence OD turning
- ⑤ Z5.0 F0.05 OD turning
- ⑥ Y13.0 Return to start position
- ⑦ G00X20.0 Tool exit

Note) Ensure to first move ② Y-axis before ③ moving to the start position.

Difference in tool overhang

Due to the difference in overhang from conventional X-axis tools, Y-axis tool needs special attention to avoid collision with the workpiece during the slide movement. To ensure safety, program so that the cutting head stays clear from the workpiece.

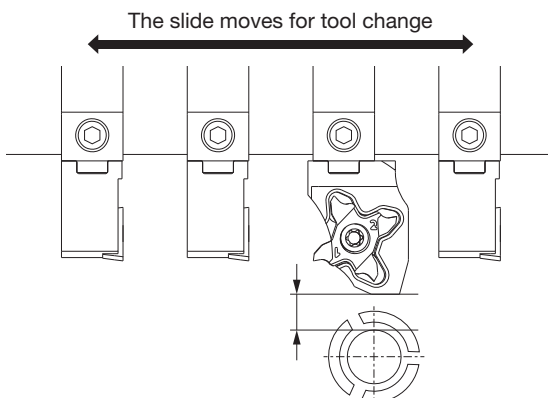

Caution when installing the shank on the gang slide

To ensure secure tool coupling, install the shank on the gang slide so that the shank edge protrudes 0.5 mm or more from the edge of the slide unit. Make sure that the cutting head and the slide unit are NOT in contact.

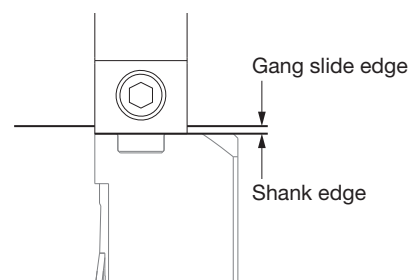

● Reduction of machinable barstock diameters

Depending on the Y-axis cutting tool's location and orientation on the gang tool slide, machinable barstock diameter may vary. To avoid tool collision and damage with the workpiece, check the machinable barstock size in the list below before using Y-axis cutting head.

Note: The values in the list are calculated, provided that the cutting tools on the slide are all accurately set to the equal tool length before operation.

A When there is no tool located in the feed direction of Y-axis tool

Ex.) Y-axis tool is located at the very end of the slide facing outward

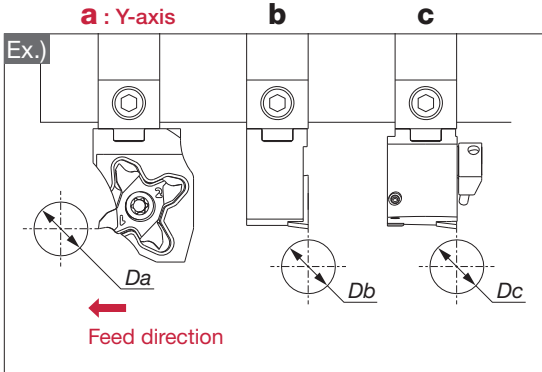

Tool position	a	b	c
Cutting head type	Y-axis head	X-axis head	X-axis head
Machinable barstock dia.	No restriction for the D_a value	$D_b = \varnothing 70$ mm	No restriction for the D_c value

B When there is a tool located in the feed direction of the Y-axis tool

B-1: When X-axis tool is in the Y-axis feed direction

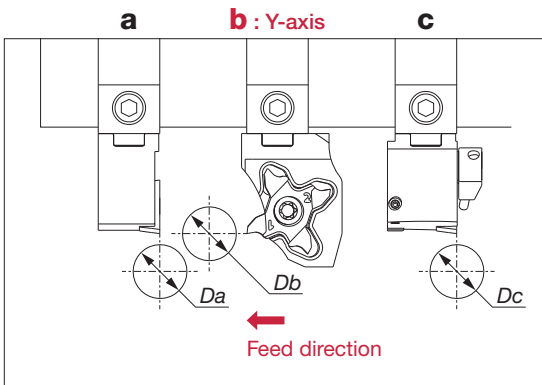

Tool position	a	b	c
Cutting head type	X-axis head	Y-axis head	X-axis head
Machinable barstock dia.	No restriction for the D_a value	See below for the D_b value	$D_c = \varnothing 70$ mm

Calculation for D_b

$$D_b = \text{Distance between the cutting points} - 2 \text{ mm (for the holder clearances)}$$

Ex.) Given that the two cutting points are 15 mm apart,

$$D_b = 15 - 2 = \varnothing 13 \text{ mm}$$

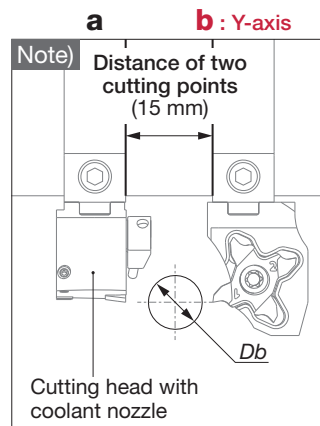
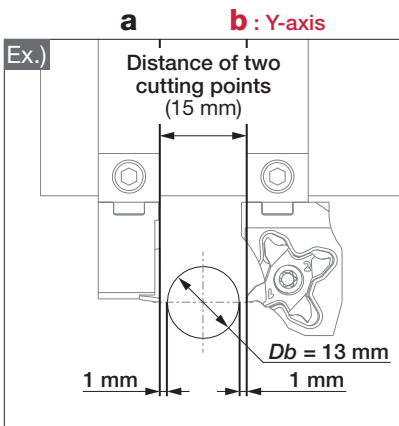

Note) When Y-axis tool is adjacent to a tool with coolant nozzle, a collision may occur even if a proper distance is maintained between the tools. For such tool setup, always use precautionary measures to avoid interference before starting the operation.

B-2: When another Y-axis tool is in the Y-axis feed direction

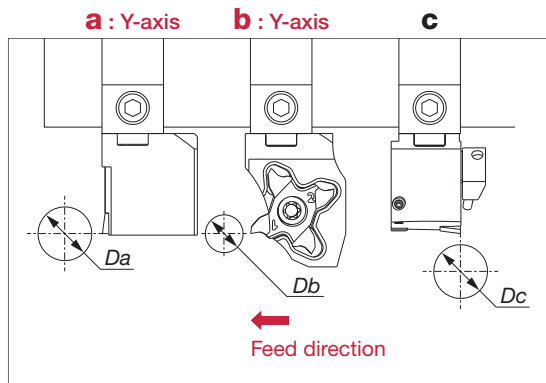

Tool position	a	b	c
Cutting head type	Y-axis head	Y-axis head	X-axis head
Machinable barstock dia.	No restriction for the D_a value	See below for the D_b value	$D_c = \phi 70$ mm

Calculation for D_b

D_b = Distance between the two cutting points – Max head width – 2 mm (for the clearances)

Max head width = Head width (H2) – Shank width (B)

See the catalog for the tool's H2 and B sizes.

Ex.) Given: the cutting point distance = 15 mm

Using QC12-JSCL2CR09-Y-CHP as the adjacent tool (H2 = 18.6 mm, B = 12 mm)

$$D_b = 15 - (18.6 - 12) - 2 = \phi 6.4 \text{ mm}$$

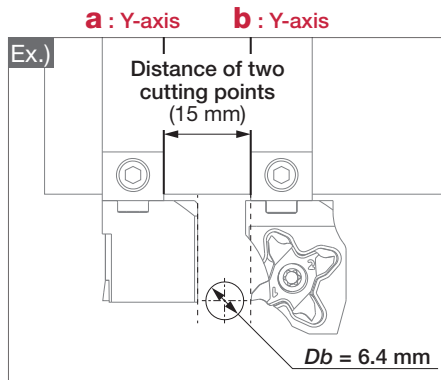

Chart sheet for the D_b values when using ModuMini-Turn Y-axis cutting head

Y-axis cutting head	Distance between the two tools (mm)	H2 (mm)	Shank width B (mm)	Machinable barstock dia. D_b (mm)
QC12-JSCL2CR09-Y (-CHP)	15	18.6	12	$\phi 6.4$
QC12-JSDJ2CR11-Y (-CHP)		18.7	12	$\phi 6.3$
QC12-JSWL2XR04-Y (-CHP)		12	12	$\phi 13$
QC12-JSDJ2XR07-Y (-CHP)		12.5	12	$\phi 12.5$
QC12-STCR/L18-Y (-CHP)		18.6	12	$\phi 6.4$
QC12-STOPPER		-	12	$\phi 21$

■ Cutting point offset in the radial (X-axis) direction

● Setting Method

To offset the cutting point position in the radial (X-axis) direction during the tool setup, lower the flat (the red-colored area) of the cutting head to contact the workpiece, then compensate the tool position by offsetting the program for the distance between the flat and the cutting point (see the list below for the offset values).

Presetting

- Bring the flat into contact with the workpiece and preset the value for the radial (X-axis) direction.

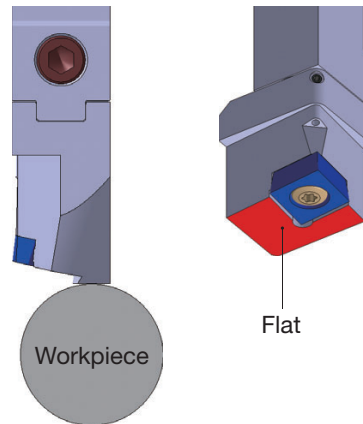

Programming

- The offset values for the cutting point are shown in the list below.
- Set the offset value in the machining program to compensate the cutting point position.

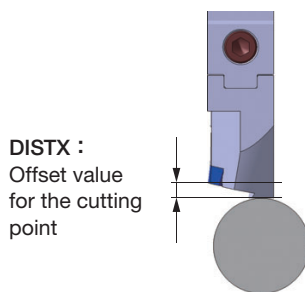

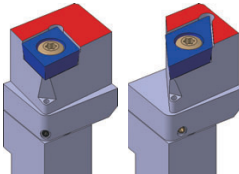
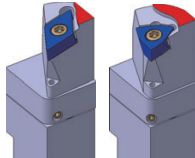
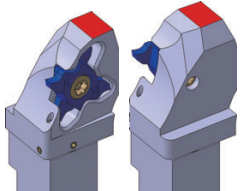
Offset values for Y-axis cutting head types			
	J-SERIES	MINIFURN	TETRAMCUT
Y-axis cutting head	 QC12-JSCL2CR09-Y (-CHP) QC12-JSDJ2CR11-Y (-CHP)	 QC12-JSDJ2XR07-Y (-CHP) QC12-JSWL2XR04-Y (-CHP)	 QC12-STCR/L18-Y (-CHP)
DISTX Offset value for the cutting point	0.3 mm (Ref.)	2.8 mm (Ref.)	6.5 mm (Ref.)

Tungaloy Corporation (Head office)

11-1 Yoshima-Kogyodanchi
Iwaki-city, Fukushima 970-1144 Japan
Phone: +81-246-36-8501
Fax: +81-246-36-8542
www.tungaloy.co.jp

Tungaloy America, Inc.

3726 N Ventura Drive
Arlington Heights, IL 60004, U.S.A.
Phone: +1-888-554-8394
Fax: +1-888-554-8392
www.tungaloy.com/us

Tungaloy Canada

432 Elgin St. Unit 3
Brantford, Ontario N3S 7P7, Canada
Phone: +1-519-758-5779
Fax: +1-519-758-5791
www.tungaloy.com/ca

Tungaloy de Mexico S.A.

C. Los Arellano 113,
Parque Industrial Siglo XXI
Aguascalientes, AGS, Mexico 20290
Phone: +52-449-929-5410
Fax: +52-449-929-5411
www.tungaloy.com/mx

Tungaloy do Brasil Ltda.

Avd. Independencia N4158 Residencial Flora
13280-000 Vinhedo, São Paulo, Brasil
Phone: +55-19-38262757
Fax: +55-19-38262757
www.tungaloy.com/br

Tungaloy Germany GmbH

An der Alten Ziegelei 1
D-40789 Monheim, Germany
Phone: +49-2173-90420-0
Fax: +49-2173-90420-19
www.tungaloy.com/de

Tungaloy France S.A.S.

ZA Courtaboeuf - Le Rio
1 rue de la Terre de feu
F-91952 Courtaboeuf Cedex, France
Phone: +33-1-6486-4300
Fax: +33-1-6907-7817
www.tungaloy.com/fr

Tungaloy Italia S.r.l.

Via E. Andolfato 10
I-20126 Milano, Italy
Phone: +39-02-252012-1
Fax: +39-02-252012-65
www.tungaloy.com/it

Tungaloy Czech s.r.o.

Turanka 115
CZ-627 00 Brno, Czech Republic
Phone: +420-532 123 391
Fax: +420-532 123 392
www.tungaloy.com/cz

Tungaloy Ibérica S.L.

C/Miquel Servet, 43B, Nau 7
Pol. Ind. Bufalvent
ES-08243 Manresa (BCN), Spain
Phone: +34 93 113 1360
Fax: +34 93 876 2798
www.tungaloy.com/es

Tungaloy Scandinavia AB

Bultgatan 38
442 40 Kungälv, Sweden
Phone: +46-462119200
Fax: +46-462119207
www.tungaloy.com/se

Tungaloy Rus, LLC

Andropova avenue, h.18/7,
11 floor, office 3, 115432,
Moscow, Russia
Phone: +7-499-683-01-80
Fax: +7-499-683-01-81
www.tungaloy.com/ru

Tungaloy Polska Sp. z o.o.

Ul. Irysowa 1, 55-040 Bielany
Wroclawskie, Poland
Phone: +48 607 907 237
www.tungaloy.com/pl

Tungaloy U.K. Ltd

Gallan Park, Watling Street,
Cannock, WS110XG, UK
Phone: +44 121 4000 231
Fax: +44 121 270 9694
www.tungaloy.com/uk

Tungaloy Hungary Kft

Erzsébet királyné útja 125
H-1142 Budapest, Hungary
Phone: +36 1 781-6846
Fax: +36 1 781-6866
www.tungaloy.com/hu

Tungaloy Turkey

Serifali Mah.bayraktar Bulvari Kule Sk. No:26
34775 Umraniye / Istanbul / Turkey
Phone: +90 216 540 04 67
Fax: +90 216 540 04 87
www.tungaloy.com/tr

Tungaloy Benelux b.v.

Tjalk 70
NL-2411 NZ Bodegraven, Netherlands
Phone: +31 172 630 420
Fax: +31 172 630 429
www.tungaloy.com/nl

Tungaloy Croatia

Ulica bana Josipa Jelačića 87,
10430, Samobor, Croatia
Phone: +385 1 3326 604
Fax: +385 1 3327 683
www.tungaloy.com/hr

Tungaloy Cutting Tool (Shanghai) Co.,Ltd.

Rm No 401 No.88 Zhabei
Jiangchang No.3 Rd
Shanghai 200436, China
Phone: +86-21-3632-1880
Fax: +86-21-3621-1918
www.tungaloy.com/cn

Tungaloy Cutting Tools (Taiwan) Co.,Ltd.

9F, No.293, Zhongyang Rd,
Xinzhuan Dist, New Taipei City,
24251 Taiwan
Phone: +886-2-8521-9986
Fax: +886-2-8521-8935
www.tungaloy.com/tw

Tungaloy Cutting Tools (Thailand) Co.,Ltd.

Interlink tower 4th Fl.
1858/5-7 Bangna-Trad Road
km.5 Bangna, Bangna, Bangkok 10260
Thailand
Phone: +66-2-751-5711
Fax: +66-2-751-5715
www.tungaloy.com/th

Tungaloy Singapore (Pte.), Ltd.

62 Ubi Road 1, #06-11 Oxley BizHub 2
Singapore 408734
Phone: +65-6391-1833
Fax: +65-6299-4557
www.tungaloy.com/sg

Tungaloy Vietnam

LE04.38, Lexington Residence
67 Mai Chi Tho St., Dist. 2,
Ho Chi Minh City, Vietnam
Phone: +84-2837406660
www.tungaloy.com/sg

Tungaloy India Pvt. Ltd.

Indiabulls Finance Centre,
Unit # 902-A, 9th Floor,
Tower 1, Senapati Bapat Marg,
Elphinstone Road (West),
Mumbai -400013, India
Phone: +91-22-6124-8804
Fax: +91-22-6124-8899
www.tungaloy.com/in

Tungaloy Korea Co., Ltd

#1312, Byucksan Digital Valley 5-cha
Beotkkot-ro 244, Geumcheon-gu
153-788 Seoul, Korea
Phone: +82-2-2621-6161
Fax: +82-2-6393-8952
www.tungaloy.com/kr

Tungaloy Malaysia Sdn Bhd

50 K-2, Kelana Mall, Jalan SS6/14
Kelana Jaya, 47301
Petaling Jaya, Selangor Darul Ehsan
Malaysia
Phone: +603-7805-3222
Fax: +603-7804-8563
www.tungaloy.com/my

Tungaloy Australia Pty Ltd

Unit 68 1470 Ferntree Gully Road
Knoxfield 3180 Victoria, Australia
Phone: +61-3-9755-8147
Fax: +61-3-9755-6070
www.tungaloy.com/au

PT. Tungaloy Indonesia

Kompleks Grand Wisata Block AA-10 No.3-5
Cibitung
Bekasi 17510, Indonesia
Phone: +62-21-8261-5808
Fax: +62-21-8261-5809
www.tungaloy.com/id



www.tungaloy.com

follow us at:

facebook.com/tungaloyjapan
twitter.com/tungaloyjapan
www.youtube.com/tungaloycorporation



AS9100 Certified
78006
2015.11.04
ISO 14001 Certified
EC97J1123
1997.11.26

Distributed by:



FIND US ON THE CLOUD!
machingcloud.com

